

EUROPEAN ORGANIZATION FOR NUCLEAR RESEARCH
European Laboratory for Particle Physics
CERN – TS DEPARTMENT

EDMS Nr. 804849

TS-Note-2006-010

**Chemical and radiolytical characterization of some perfluorocarbon
fluids used as coolants for LHC experiments**

Chemical characterization

M. Battistin, S. Ilie, R. Setnescu, B. Teissandier

Abstract

Perfluorocarbon fluids, - mainly C₆F₁₄ - used as coolants within High Energy Physics Detectors in the Large Hadrons Collider (LHC) at CERN, were characterized by applying mainly the following methods: GC, FT-IR and UV-Vis. The aim of this work was the quality control, the identification and the quantification of different impurities which could increase the radiation sensitivity of these fluids. Thus, the presence of H containing molecules within perfluorocarbons strongly influences the appearance of hydrofluoric acid during their irradiation. The procedures settled-up in this work are sensitive to the presence of such impurities and would be used for the analyses of the received perfluorocarbon fluids as well as to assess the radiation induced modifications and the efficiency of their purification treatments.

Geneva, Switzerland
October 2006

1. INTRODUCTION

Perfluorocarbons will be used as cooling fluids within the detector inner parts of the LHC experiments, in a high ionizing radiation field.

The purpose of the report is to present the work carried out in CERN for the characterization of C₆F₁₄ cooling perfluorocarbons using different methods and techniques (spectral, chromatographic, potentiometric, chemical, etc.), the behavior of the perfluorocarbons in the radiation fields, as well as their possible purification. Further it was decided to study also the perfluoropropane (C₃F₈), used as a cooling fluid in the evaporative mode.

The present part – Part One – of the report refers to the analyses carried out and the compliance of the obtained results and the procedures applied in CERN to the technical specifications delivered by the suppliers.

An important part of this work was focused on the identification and the quantification of different impurities which could increase the radiation sensitivity of these fluids. Thus, the presence of H containing molecules within perfluorocarbons strongly influence the appearance of hydrofluoric acid during their irradiation, while the presence of double bonds can induce the appearance of polymers and/or pre-polymers. The procedures settled-up in this work were found to be sensitive to the presence of such impurities and would be used to characterize the as received perfluorocarbon fluids, as well as their radiation induced modifications. In some cases, several different analytical methods were tested for one parameter as shown in Ch. 4, in order to found the most adequate one, or to validate a certain analyze method proposed. In other cases, the procedures given by the supplier (such as density or boiling point measurements) were directly applied.

Our strategy envisaged also to apply adequate treatments to less pure, hence less expensive fluids, in order to fulfil the CERN technical requirements and enlarge the range of the potential suppliers.

2. CERN TECHNICAL REQUIREMENTS AND PERFLUOROCARBON FLUIDS STUDIED

The CERN quality (technical) requirements cf. IT 3397/TS for the perfluorocarbon fluids to be supplied are summarized in Table 1 and Table 2; the main types received and studied within the present work are summarized in Table 3.

The analyze documents of the supplied fluids are listed in Table 4. The specifications from F2 (UK) for C₆F₁₄ (iso-C₆F₁₄ or 2-perfluoromethylpentane) and Astor (Russia) for C₃F₈ fulfill the CERN technical requirements. The specifications from 3M (USA) for n-C₆F₁₄ (PF 5060 and PF 5060 DL) does not refer to all CERN requirements, therefore their characterization in CERN was carried out in the Chemistry Laboratory.

Table 1 – Perfluoropropane quality specification

Parameter	Unit	Lower limit	Upper limit
C ₃ F ₈ organic purity	% volume	99.96	
Other Perfluorocarbons	ppm weight		400
C ₃ F ₈ double bounded molecules	ppm weight		10
H containing molecules	ppm weight		10
Air (O ₂ , N ₂ , CO ₂)	ppm vol.		200
Water	ppm weight		1
Free fluoride	ppm weight		0.1

Table 2 – Perfluorohexane quality specification

Parameter	Unit	Lower limit	Upper limit
C ₆ F ₁₄ purity by GLC (area %)	%	98	
Other Perfluorocarbons	%		2
C ₆ F ₁₄ double bounded molecules	ppm weight		10
H containing molecules	ppm weight		10
Water	ppm weight		10
Free fluoride	ppm weight		1
Density	g/ml	1.660	1.700
Boiling point	°C	51	59

Table 3 – The main perfluorocarbon fluids studied in this work

No.	Product name	Supplier	Composition	Name used in this report
1	PF 5060	3M Chemicals, USA	mainly n-C ₆ F ₁₄ (n-perfluorohexane)	PF 5060
2	PF 5060 "purified"	3M Chemicals, USA; tentatively " treated" (purified) in CERN Chemistry Lab. to meet the quality requirements cf. IT 3397/TS	mainly n-C ₆ F ₁₄ (n-perfluorohexane)	purified PF 5060
3	PF 5060 DL	3M Chemicals, USA	mainly n-C ₆ F ₁₄ (n-perfluorohexane)	PF 5060 DL
4	Flutec PP1	F2 Chemicals Ltd., UK	mainly iso-C ₆ F ₁₄ (iso-perfluorohexane)	PP1
5	C ₃ F ₈ (R218)	ASTOR, Russia	C ₃ F ₈ perfluoropropane	C ₃ F ₈ perfluoropropane

Table 4 – The analyse documents of the perfluorocarbon fluids supplied to CERN

No.	Product name	Supplier	Technical Specification	Document
1	PF 5060	3M Chemicals, USA	3M Technical Specifications for PF-5060 / 28 August 2002	Certificate of Compliance/ Analysis (19 Sep.05)
2	PF 5060 DL	3M Chemicals, USA	3M Technical Specifications for PF-5060DL / 13 Feb. 2001	Certificate of Analysis Lot. Nbr. 20032/ 13 Mar. 2006
3	Flutec PP1	F2 Chemicals Ltd., UK	F2 Chemicals Ltd. Specification Sheet QCS 38	Certificate of Analysis Batch No 0294/ Ref. No. P51917
4	C ₃ F ₈ (R218)	ASTOR, Russia	ASTOR Specification	AST 427/ 02 Dec. 2005

3. INSTRUMENTS, METHODS AND PROCEDURES

3.1 Gas-chromatograph with mass spectrometer detector (GC-MSD)

A GC-MSD Agilent 6890 Series GC System with a 60 m capillary GasPro column coupled to the Agilent 5973 Mass Selective Detector was used. The analytical parameters were optimized as follows:

- **C₃F₈ analysis**
 - detector: 250 °C
 - heater: 260 °C
 - carrier gas flow: 0.9 mL/ minute
 - split 300:1; sample gas loop 0.25 mL, previously pumped out
 - initial temperature: 90 °C
 - initial time: 15 minutes
 - heating rate: 20 °C/ minute
 - final temperature: 170 °C
 - final time: 10 minutes
- **C₆F₁₄ analysis**
 - detector: 250 °C
 - heater: 260 °C
 - carrier gas flow: 0.9 mL/minute
 - split 300:1; sample injections between 2 µL and 10 µL
 - initial temperature: 120 °C
 - initial time: 20 minutes
 - heating rate: 8 °C/ minute
 - final temperature: 200 °C
 - final time: 10 minutes

3.2 Gas-chromatograph with TCD detector (GC-TCD)

A GC Hewlett - Packard 5890 with a Thermal Conductivity Detector (TCD) and a 4 m, 1/8'', packed Porapak Q column was used. The analytical parameters were optimized as follows:

- **C₃F₈ analysis**
 - oven temperature: 80 °C (isotherm)
 - injector: 130 °C
 - detector: 140 °C
 - sample gas loop 0.25 mL, previously pumped out.
- **C₆F₁₄ analysis**

Method PFC 2006B

 - injector: 140 °C
 - detector: 180 °C
 - initial temperature: 140 °C
 - initial time: 45 minutes
 - heating rate: 8 °C/ minute
 - final time: 20 minutes
 - final temperature: 170 °C
 - sample injections: between 2 µL and 10 µL

Method PFC 2006C

- - injector: 130 °C
- - detector: 160 °C
- - initial temperature: 110 °C
- - initial time: 20 minutes
- - heating rate: 20 °C/ minute
- - final time: 45 minutes
- - final temperature: 150 °C
- - sample injections: between 2 µL and 10 µL

3.3 Fourier Transform-Infrared Spectroscopy (FT-IR)

A **Bruker FT-IR spectrometer Vertex 70** was used, with the following settings:

- aperture: 6 mm
- resolution: 4 cm⁻¹
- sample scan time: 32 scans
- transmission or absorbance mode
- ZnS cells (Cleartran)
- optical path length: 0.5 mm
- all analyses were realized in liquid phase

3.4 UV-Vis Spectrophotometry

An **UV-Vis Spectrophotometer Agilent 8453** was used, with the following parameters:

- spectral range: 190 – 1100 nm
- diode array, mono-beam
- silica cells
- optical path length: 1 cm
- air or purified C₆F₁₄ were used as references.

3.5 Free fluoride ion analysis

The fluoride ion (F⁻) concentration was measured by a potentiometric method with the instrument **Methrom Titrand 809**, using a fluoride ion-selective electrode, a reference Ag/AgCl (double junction filled with KCl solution, 3 mol/L) and magnetically stirred solution. The calibration curve was established using appropriate NaF standard solutions. The measurements were realized at a fixed ionic strength using a TISAB III¹ solution (10 % reported to total volume of the analyzed solution). All used vessels were in plastic materials (mainly polypropylene).

3.6 Boiling points (distillation ranges) measurements

The boiling points (distillation ranges) of the perfluorocarbon fluids were measured according to the procedure FC-40-106 (F2 Chemicals Ltd.) [1] and the British Standard 658 [2]. The distillation installation used is shown in the Fig. 1.

¹ Total Ionic Strength Adjustment Buffer

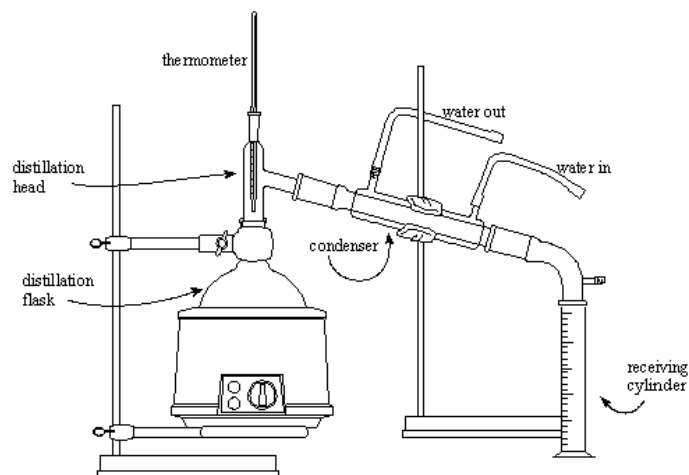

Fig. 1 - The installation used for the distillation of perfluorocarbon fluids

In the condenser was circulated cold water (7-8°C) from a RMT 6 Lauda thermostat. The distilling sample was heated by a thermostatic electric plate on a water bath (at 50 °C). Subsequently, the bath temperature was progressively increased (1 °C) at every 6 minutes. The bath temperature was kept constant during the distillation of a certain fraction. A magnetic stirrer was used to homogenize the temperature in the water bath. The sample volume (100 mL) was transferred in the distillation flask and pellets of molecular sieve were added to regularize the boiling process. The distilled volume was continuously measured as a function of the condensing vapors temperature.

3.7 Density measurements

The density values were measured using the Gay-Lussac pycnometer as described in the procedure FC-40-108 (F2 Chemicals Ltd.) [1] and in the British Standard 4522 [2].

A thermostatic bath (Lauda RMT 6) - was used to keep the sample at the pre-established temperature (i.e. 20.0 °C; precision: ± 0.1°C).

The observed density (d_0) was calculated as follows:

$$d_0 = \frac{w_f - w_i}{V} \quad (1)$$

where w_f and w_i are, respectively, the weights of the pycnometer filled with perfluorocarbon fluid and the empty one; V is the volume of the pycnometer.

Two measurements were done for every material and the average values were taken into consideration.

The corrected density (d_c) is calculated using the formula recommended by F2 Chemicals supplier [1]:

$$d_c = d_0 + K(T-20) \quad (2)$$

where T is the temperature of the pycnometer + liquid (in °C) and K is a constant depending on the chemical nature of the liquid to be measured. All measurements were performed at 20.0 °C, hence $d_c = d_0$.

4. RESULTS

4.1 Determination of C_6F_{14} organic purity using gas-chromatography

GC-MSD and GC-TCD methods were applied to determine the purity of the perfluorocarbon fluids received in CERN. The ratio of the *main peak area/ total area* resulted from each peak integration was used to calculate the organic purity. The typical chromatograms are shown in Figs. 2. to 5.

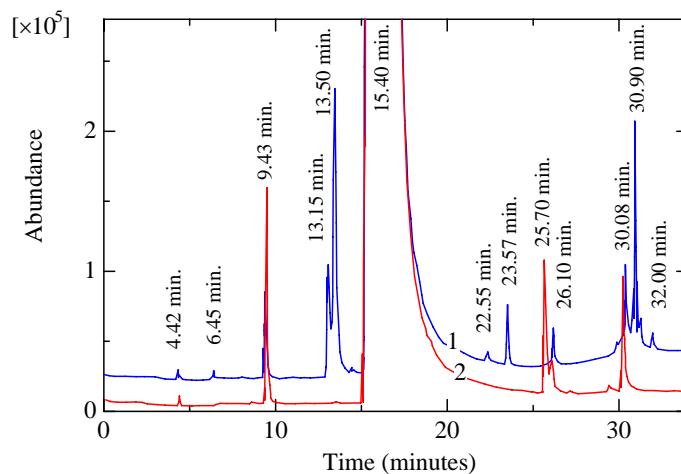

Fig. 2 – Typical GC-MSD chromatograms of C_6F_{14} fluids: 1 - PF 5060; 2 - PP1

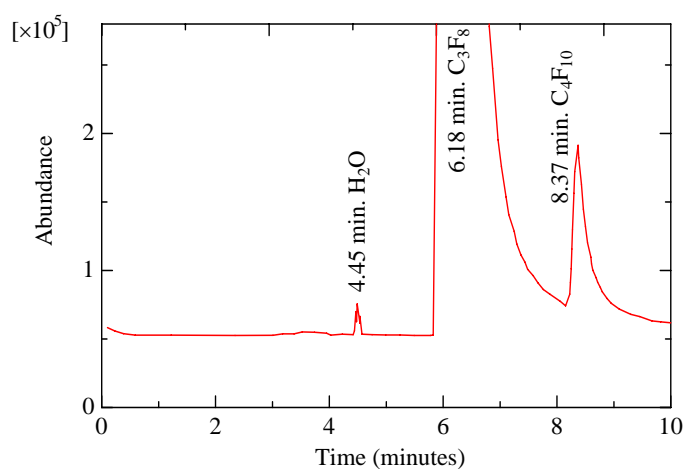

Fig. 3 – Zoom on a typical GC-MSD chromatogram of C_3F_8

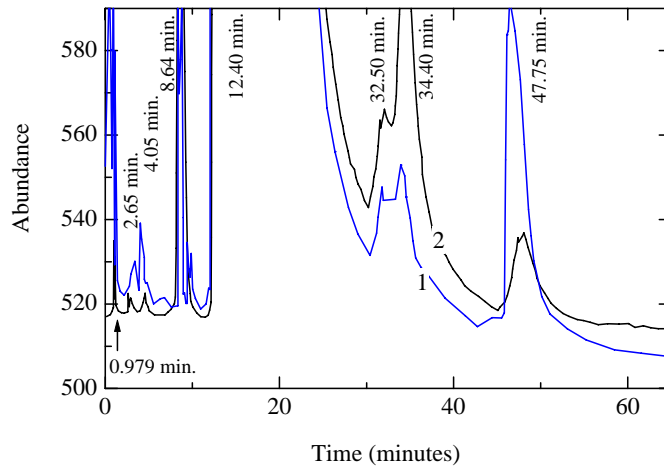

Fig. 4 – Zoom on typical GC-TCD chromatograms of C_6F_{14} fluids (Method PFC 2006 B): 1 - PF 5060; 2 - PPI.

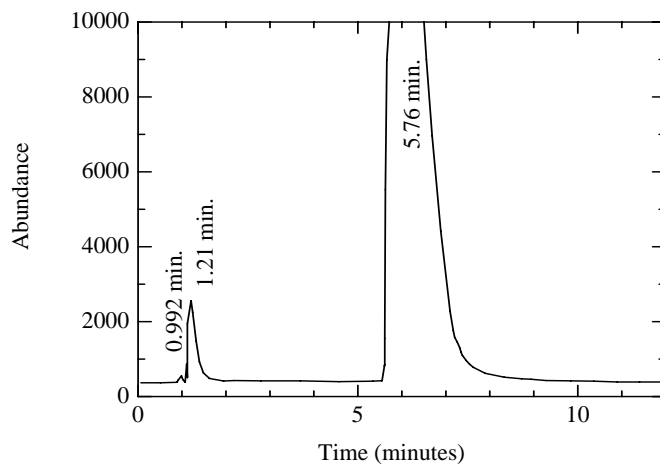

Fig. 5 – Zoom on a typical GC-TCD chromatogram of C_3F_8

In all cases, the main peak was assigned to the main component (C_6F_{14} and C_3F_8 respectively). The results obtained by GC-MSD analysis are summarized in Table 5. As it can be seen, **all the analyzed fluids meet the CERN requirements concerning the organic purity** as it was assessed by GC-MSD. It should be mentioned that the spectrum of C_3F_8 exhibited a small shoulder (ca. 0.03 % of area) on the main peak. The molecular fragments identified by mass spectroscopy correspond to a mixture C_3F_8 and C_4F_{10} , co-eluted on the GasPro column.

Table 5 – Organic purity of the perfluorocarbon received in CERN, analyzed by GC-MSD method

Sample	Code	Main peak r.t. (min.)	Main peak area (arb. units)	Total area (arb. units)	Purity (%)	Averaged purity (%)
PF 5060	038D	15.74	$3.1048 \cdot 10^9$	$3.1349 \cdot 10^9$	99.040	98.964
	042D	15.59	$4.0646 \cdot 10^9$	$4.1062 \cdot 10^9$	98.987	
	045D	15.25	$6.3169 \cdot 10^9$	$6.3894 \cdot 10^9$	98.865	
Purified PF 5060	037D	15.44	$5.0410 \cdot 10^9$	$5.0895 \cdot 10^9$	99.047	99.052
	046D	15.49	$4.6868 \cdot 10^9$	$4.7314 \cdot 10^9$	99.057	
PF 5060 DL	047D	15.55	$4.3544 \cdot 10^9$	$4.3958 \cdot 10^9$	99.058	99.023
	048D	15.40	$5.3239 \cdot 10^9$	$5.3783 \cdot 10^9$	98.988	
PP1	034D	15.19	$5.4215 \cdot 10^9$	$5.4620 \cdot 10^9$	99.259	99.259
	044D	15.05	$6.9430 \cdot 10^9$	$6.9948 \cdot 10^9$	99.259	
C ₃ F ₈	01D	6.225	$5.2779 \cdot 10^9$	$5.2798 \cdot 10^9$	99.964	99.964
	02D	6.208	$4.1726 \cdot 10^9$	$4.1736 \cdot 10^9$	99.975	
	03D	6.164	$4.1929 \cdot 10^9$	$4.199 \cdot 10^9$	99.952	

The results obtained by GC-TCD method confirm (see Table 6) the results obtained by GC-MSD. However, C₃F₈, exhibited a peak at 1.21 min. (ca. 2 % of the area, see Fig. 5). This peak presumably resulted from bottle distillation, i.e. CF₄ was preferentially concentrated in the gas atmosphere of the bottle². Therefore, based on GC-MSD and taking account the above noticed phenomena, it can be considered that C₃F₈ meet also the CERN requirements for organic purity.

Table 6 – Organic purity of the perfluorocarbon received in CERN, analyzed by GC-TCD method

Sample	Code	Main peak r.t. (min.)	Main peak area (arb. units)	Total area (arb. units)	Purity (%)	Average purity (%)
PF 5060	031	12.57	$5.1967 \cdot 10^6$	$5.2247 \cdot 10^6$	99.464	99.416
	038	12.29	$5.4194 \cdot 10^6$	$5.4539 \cdot 10^6$	99.367	
Purified PF 5060	032	12.22	$5.5190 \cdot 10^6$	$5.5414 \cdot 10^6$	99.600	99.577
	034	12.36	$5.3765 \cdot 10^6$	$5.4006 \cdot 10^6$	99.554	
PF 5060 DL	030	12.53	$5.2564 \cdot 10^6$	$5.2782 \cdot 10^6$	99.588	99.571
	035	12.57	$5.1013 \cdot 10^6$	$5.1241 \cdot 10^6$	99.554	
PP1	037	12.78	$5.3323 \cdot 10^6$	$5.3681 \cdot 10^6$	99.333	99.373
	044	12.71	$5.3092 \cdot 10^6$	$5.3445 \cdot 10^6$	99.340	
	045	12.81	$5.1036 \cdot 10^6$	$5.1326 \cdot 10^6$	99.435	
	046	12.53	$5.3202 \cdot 10^6$	$5.3531 \cdot 10^6$	99.385	
C ₃ F ₈	004	5.83	$1.2532 \cdot 10^6$	$1.2783 \cdot 10^6$	98.040	97.892
	005	5.78	$1.2358 \cdot 10^6$	$1.2629 \cdot 10^6$	97.858	
	008	5.756	$1.2342 \cdot 10^6$	1.262226	97.777	

Several other peaks were observed in all analyzed spectra as it can be seen in Figs. 2 to 5. The assignment of these peaks was realized using injections of chemically known samples and also the NIST MS library. In some cases, it was difficult to confirm these assignments because of the lack of several pure fluorinated compounds. A list is shown in Table 7. and Table 8. for the peaks in C₆F₁₄ analysis by GC-MSD and GC-TCD, respectively.

² It should be noticed that GC-TCD experiments were performed using one sample bottle, before those of GC-MSD: this could explain the small value of the CF₄ peak in GC-MSD chromatograms (a peak containing mainly the fragments corresponding to water, air and CO₂ was observed at the beginning of each chromatogram).

Table 7 – Assignment of some peaks as observed in GC-MSD spectra of C₆F₁₄ fluids

Retention time (minutes)	Assignment	Confirmed by control samples
4.42	water + air	+
6.45	C ₄ F ₁₀	-
9.43	C ₅ F ₁₂	-
13.15	CF ₃ CF(CF ₃)CF ₂ CF ₃	-
13.50	cyclo-C ₆ F ₁₂	-
15.40	C ₆ F ₁₄ (n, iso)	+
22.55	1-C ₆ F ₁₂	+
23.57	Hexane	+
25.70	Perfluorocarbons homologues of C ₆ F ₁₄	-
26.10		-
30.08	H-C ₆ F ₁₃	+

Table 8 – Assignment of some peaks as observed in GC-TCD spectra of C₆F₁₄ fluids

Retention time (minutes)	Assignment	Confirmed by control sample
0.979	air	+
2.65	CO ₂	+
4.05	H ₂ O	+
8.64	C ₅ F ₁₂	+
12.40	C ₆ F ₁₄ (n + iso)	+
12.40	C ₆ F ₁₂ (co-eluted with C ₆ F ₁₄)	+
32.50	perfluorinated homologues of C ₆ F ₁₄	-
34.40	perfluorinated homologues of C ₆ F ₁₄	-
35.40	H-C ₆ F ₁₃	+
47.75	Hexane	+

Similar results were obtained under different working conditions, too.

To conclude, it can be said that the perfluorocarbon fluids received in CERN and analyzed by the two GC methods in the Chemistry Laboratory, are compliant to the CERN technical requirements concerning the organic purity, i.e. the content in the main component, C₆F₁₄ or C₃F₈³, respectively.

4.2 Detection and dosage of the H containing molecules

Hydrogen containing molecules are sources of HF formation. Possible sources of hydrogen-containing compounds are either the raw materials (hexane, from hexane fluorination process used in 3M technology) or the accidental pollution with greases or oils during synthesis, stocking or service.

Owing the potential importance of the hydrogen atoms eventually presents within the cooling fluids which have to sustain high radiation doses during their use, efforts were also made to discriminate between the H-containing molecules: alkanes (only constituted from carbon and hydrogen atoms) and H-substituted perfluoroalkanes (constituted from carbon, fluor and hydrogen atoms). Their behavior in a radiation field may differ. More, the same fluid can contains as impurities both types of H-containing molecules. The second part of the chapter 4.2.1. presents the investigation results on this direction.

³ The compliance of the products with the CERN technical requirements are discussed for each criterion (see the corresponding chapters). Only the products which are simultaneously compliant with all the CERN technical requirements should be accepted for the CERN envisaged application.

4.2.1 FT-IR method

The detection and the dosage of H-containing molecules were carried out by FT-IR spectroscopy using the intense optical absorption bands in the region of 3000 cm^{-1} [3]. This absorption was found proportional to the concentration of hydrogen containing molecules. The following observations are to be noticed:

a) Commercially available fluids, such as PF 5060 or FC-72, show a relative intense absorption in the region of 3000 cm^{-1} confirming the presence of H containing molecules (Fig. 6).

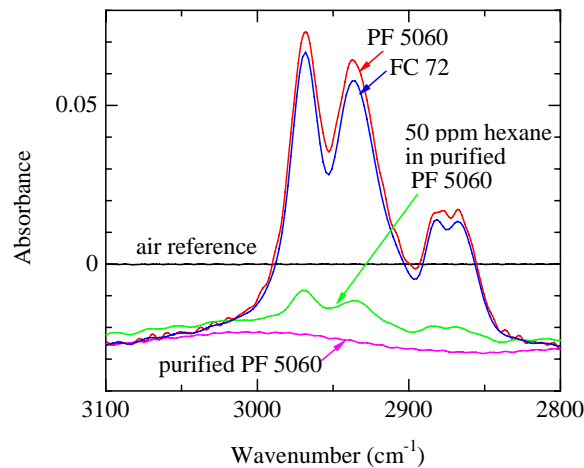

Fig. 6 – FT-IR spectra in region of 3000 cm^{-1} of some C_6F_{14} fluids

b) The absorption in the spectral range around 3000 cm^{-1} of PF 5060 samples decreased significantly after treatment by different types activated charcoal (effective in the purification of the gases, see Fig. 7); this observation is important for an eventual initial purification of the as received fluids, to make them compliant to the CERN quality requirements;

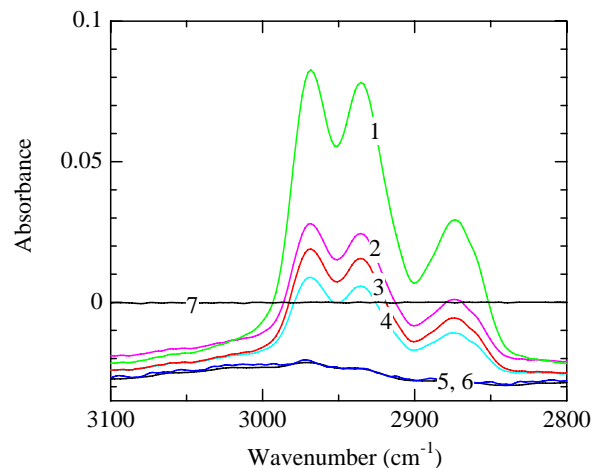

Fig. 7 – FT-IR spectra in the region of 3000 cm^{-1} of PF 5060 fluids differently treated with activated carbon: 1 - initial, as received; 2 - stirred (15') with Riedel de Haen; 3 - stirred (15') with Fluka 29204; 4 - stirred (15') with Fluka 96831; 5, 6 purified PF 5060 (passed through a laboratory multilayer adsorbent - its optimization is ongoing); 7 - air reference.

c) The optical absorption exhibited by the fluids supplied to CERN is similar to that induced in pure or purified samples by adding hexane (see Fig. 6). Low traces of hexane could be present in these fluids as non converted raw materials, as it was noted above;

d) The optical absorption in the region of 3000 cm^{-1} of the purified PF 5060 samples was lower than that of air, so negative values of the absorbance were observed when air was used as a reference (see Fig. 7); similar values of the absorbance were also obtained in the case of the both high purity products PF 5060 DL and PP1 (see data in Table 9). In the latter case, the lack of hydrogen-containing products could be related to the peculiarities of the applied technology based on the dimerization of a previously purified perfluoroalkene (i.e. C_3F_6).

To evaluate the concentration of the H-containing molecules, a completely free of hydrogen sample was prepared and a calibration curve was realized. A completely free of hydrogen sample it is not available actually on the market. As an example, the C_6F_{14} offered as high purity product by specialized suppliers, such as Sigma Aldrich or ABCR is around 85 % [4] and respectively 95 % [5] pure. Therefore, we had taken as a free of hydrogen product that sample which exhibited the lowest IR absorption in the spectral region around 3000 cm^{-1} . In this respect, many measurements were made on different samples, as received or after various treatments applied in laboratory. Finally, a limit of the optical absorption value of -0.020 (air as reference, $2 \times 2.5\text{ mm}$ ZnS windows and 0.5 mm spacer) was considered to correspond to a free hydrogen sample.

The calibration curves were obtained using the absorbance of a hydrogen free C_6F_{14} fluid containing controlled amounts of hexane.

Several series of calibration experiments were made using solutions of hexane with known concentrations and a purified C_6F_{14} as a solvent. Air (Fig. 8) or pure C_6F_{14} were used as reference (Fig. 9) to record the spectra and to get the calibration curves (Fig. 10 and Fig. 11). The detection limit was found to be lower than 2.5 ppm of hexane.

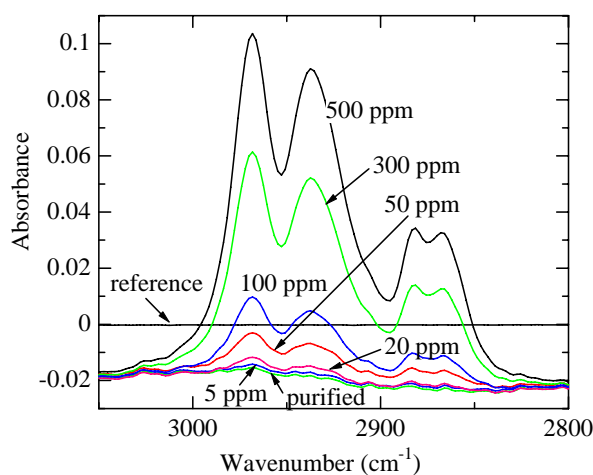

Fig. 8 – FT-IR spectra in region of 3000 cm^{-1} of hexane / C_6F_{14} solutions prepared from purified PF 5060 and various amounts of hexane; reference air.

The differences between the samples containing low amounts of hexane were more evident when purified C_6H_{14} was used as reference instead of air. Similar data series were obtained for different solutions, using as references air or C_6F_{14} , and all the results were consistent.

Note: C_6H_{14}/C_6F_{14} systems were not stable at ambient temperature. They shown a high depletion rate for C_6H_{14} (Fig. 12). This observation is to be taken into consideration for the practical procedure which should impose that only freshly prepared solutions and freshly taken out samples (or refrigerated and filled bottles) should be used.

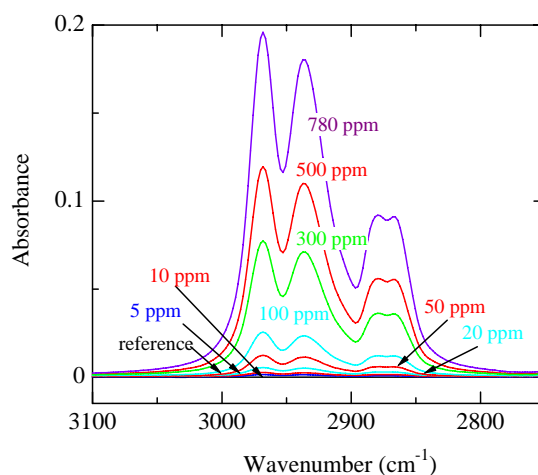

Fig. 9 – FT-IR spectra in region of 3000 cm^{-1} of hexane / C_6F_{14} solutions; reference: purified PF 5060

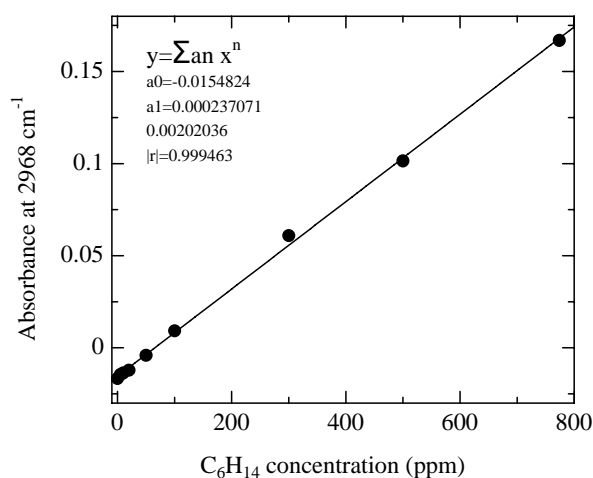

Fig. 10 – Calibration curve of absorbance (at 2968 cm^{-1}) as a function of hexane concentration; reference air.

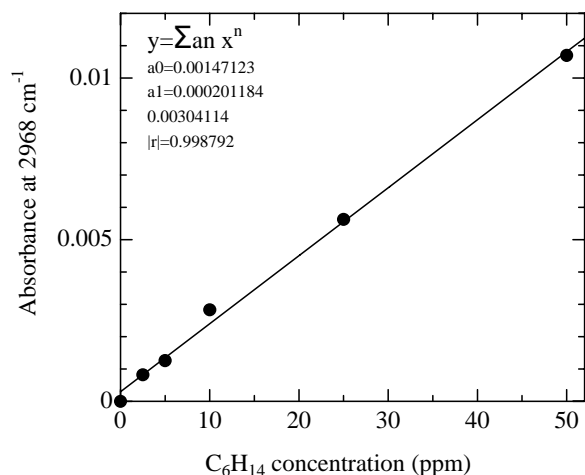

Fig. 11 a – The calibration curve of IR optical absorbance at 2968 cm^{-1} as a function of hexane concentration (low range); reference: purified PF 5060.

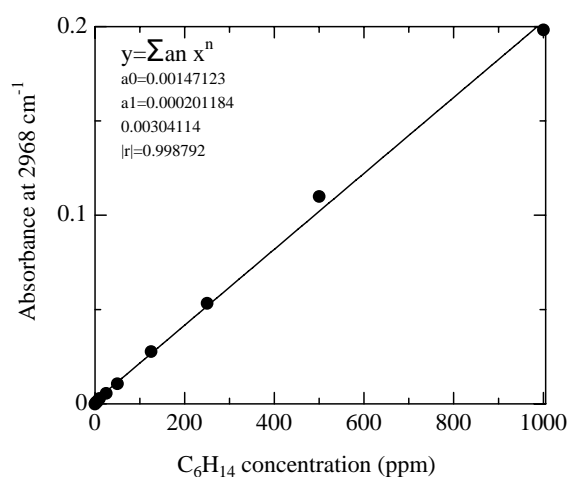

Fig. 11 b – The calibration curve of IR optical absorbance at 2968 cm^{-1} as a function of hexane concentration (high range); reference: purified PF 5060.

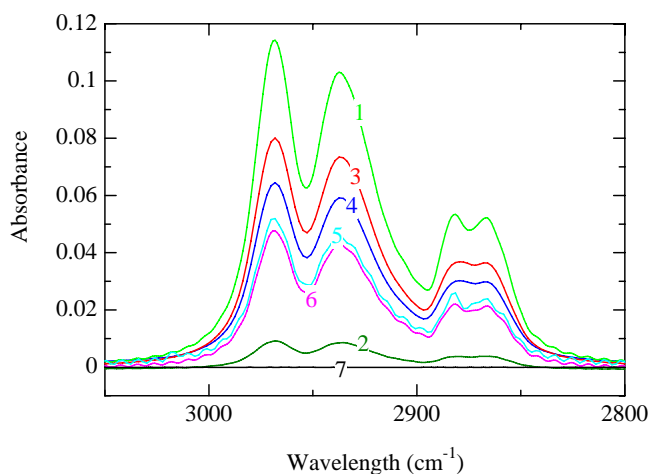

Fig. 12 – Hexane depletion shown by FT-IR measurements of C_6F_{14} samples recorded at different storage periods at room temperature: 1 – purified PF 5060 + 500 ppm of hexane; freshly prepared solution; 2 - similar solution after 2 months of storage; 3 - PF 5060 (fresh); 4 - same sample after 1 day storage and a few openings; 5 - same as 3 after 8 days (storage + few openings); 6 - same as 5 after storage in a sealed bottle for 4 months; 7 – reference: purified PF 5060.

As illustrated by the data presented in Table 9, the products PP1 and PF-5060 DL meet directly the CERN requirements concerning the H-containing molecules (alkanes), while PF 5060 and FC 72 are not compliant.

Promising results concerning the two fluids types - PF 5060 and FC 72 - were obtained: using an appropriate activated carbon purifying treatment which decreased the H-containing molecules content and the fluids became compliant from this point of view to CERN quality requirements.

Table 9 – The content of alkanes in the as received fluids; for the calibration curves, see Figs. 10 (ref. air) and Fig. 11 (ref. purified PF 5060).

Fluid type	Air reference			Purified PF 5060 reference			Average (ppm)
	Spectrum No	Absorbance (2968 cm ⁻¹)	Conc. (ppm)	Spectrum No	Absorbance (2968 cm ⁻¹)	Conc. (ppm)	
Purified PF 5060	269	-0.02164	< d l*		0 (reference)	0	0
	277	-0.02090					
	303	-0.02027					
	306	-0.01847					
	327	-0.01953					
	328	-0.01995					
	366	-0.02164					
	381	-0.02058					
	383	-0.02047					
	401	- 0.02065					
409	-0.02044						
PF 5060	239	0.12735	722	196	0.14097	695	709
	240	0.12735	722	197	0.14049	697	
PF 5060 DL	304	-0.018774	< d l*	244	-0.000666	< d l*	< d l*
	287	-0.01944		346	-0.007065		
PP1	305	-0.019366	< d l*	159	-0.000495	< d l*	< d l*
	6-F2	-0.2120		182	-0.000666		
				285	-0.002116		
				342	-0.000495		
FC-72	324	+ 0.05915	387	344	0.07702	378	395
	253	+ 0.06596	420				

* Below the detection limit (2.5 ppm)

1-H perfluorohexane (H-C₆F₁₃) was taken as a representative molecule for the H-substituted perfluoroalkanes. At high concentration levels the FT-IR spectra of H-C₆F₁₃/perfluorohexane solutions had different shapes as compared to those of hexane/perfluorohexane solutions (Fig. 13). At low H-C₆F₁₃ concentration, the FT-IR spectra (Fig. 14) exhibit the same maxima as the hexane containing C₆F₁₄, i.e. 2968 cm⁻¹, 2933 cm⁻¹ and 2868 cm⁻¹. The peak located at 2933 cm⁻¹ was higher in H-C₆F₁₃/ C₆F₁₄ solutions than in C₆H₁₄/ C₆F₁₄ ones.

The curves presented in Fig. 15 and Fig. 16 were used to evaluate the concentration of H-substituted perfluoroalkanes in the as received C₆F₁₄ fluids (Table 10). The detection limit was 2.5 ppm of H-C₆F₁₃.

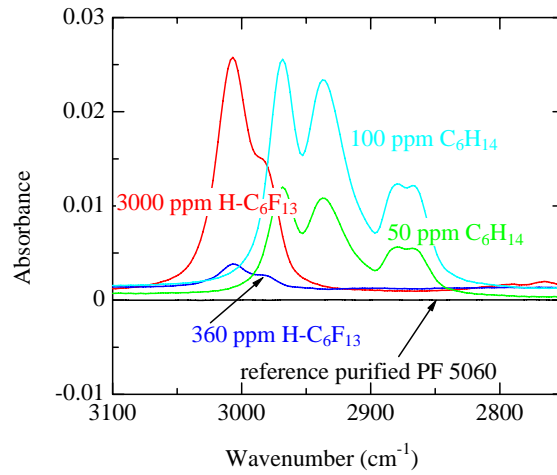

Fig. 13 – FT-IR spectra in region of 3000 cm⁻¹ of some hexane/ purified PF 5060 and H-C₆F₁₃/ purified PF 5060 solutions, reference purified PF 5060.

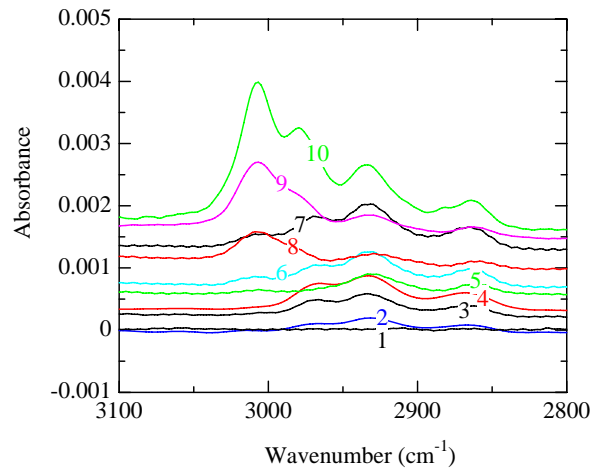

Fig. 14 – FT-IR spectra in region of 3000 cm⁻¹ of the purified PF 5060 containing various amounts of H-C₆F₁₃ 1 - reference purified PF 5060; 2 - 2.5 ppm; 3 - 5 ppm; 4 - 10 ppm; 5 - 25 ppm; 6 - 50 ppm; 7 - 100 ppm; 8 - 250 ppm; 9 - 500 ppm; 10 - 1000 ppm.

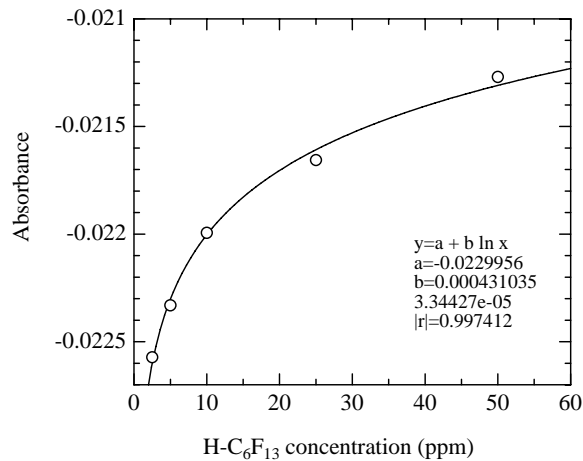

Fig. 15 – Relationship between the absorbance at 2933 cm⁻¹ and the concentration of H-C₆F₁₃ in C₆F₁₄; (reference air).

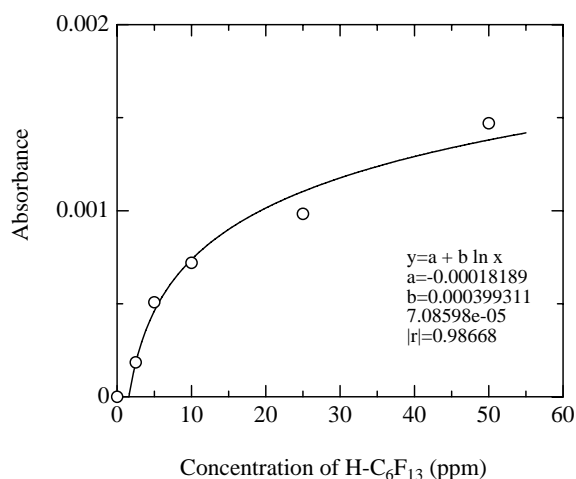

Fig. 16 – Relationship between the absorbance at 2933 cm^{-1} and the concentration of $\text{H-C}_6\text{F}_{13}$ in C_6F_{14} ; (reference purified PF 5060).

At higher concentrations of $\text{H-C}_6\text{F}_{13}$, a peak at 3007 cm^{-1} , accompanied by a shoulder at 2980 cm^{-1} starts to develop (Fig. 14) and becomes dominant at concentrations higher as 250 ppm. In these situations, is recommended to use the peak located at 3007 cm^{-1} and the curve presented in Fig. 17.

Table 10 – The content of H-substituted perfluoroalkanes in the as received fluids; for the calibration curves, see Figs. 15 (ref. air) and 16 (ref. purified PF 5060).

Spectrum No	Fluid type	Absorbance (2933 cm^{-1})	Concentration (ppm)	Average (ppm)
I. Reference air				
366	Purified PF 5060	-0.023778	-*	below the detection limit
383		-0.023344	-*	
401		-0.023441	-*	
409		-0.022958	-*	
6-F2	PP1	-0.02415	-*	below the detection limit
305		-0.02291	-*	
404		-0.02494	-*	
426		-0.02572	-*	
237	PF 5060 DL	-0.02334	-*	below the detection limit
304		-0.022910	-*	
239	PF 5060	+0.11039	**	not present**
240		+0.10801	**	
253	FC 72	+0.056383	**	not present **
324		+0.05016	**	
II. Reference purified PF 5060				
196	PF 5060	+0.12588	**	not present **
197		+0.12588	**	
244	PF 5060 DL	+0.000033	-*	below the detection limit
346		+0.000037	-*	
159	PP1	+0.000034	-*	below the detection limit
182		-0.00005	-*	
285		-0.00077	-*	
342		-0.00019	-*	
344	FC-72	0.07071	**	not present **
512		0.06376	**	

* below the detection limit (2.5 ppm)

** the optical absorption is higher than the limit of the applicability of the calibration curves caused by the presence of hexane or similar alkanes. Moreover: no peak was observed at 3007 cm^{-1} ; no optical absorption observed after activated carbon treatment; no peak attributable to $\text{H-C}_6\text{F}_{13}$ was observed on these samples measured by gas chromatography.

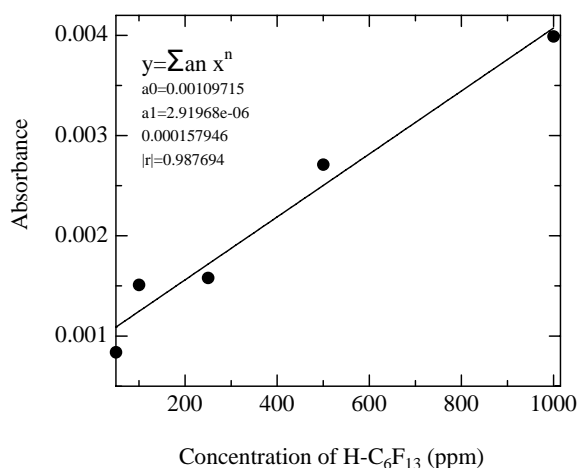

Fig. 17 – Relationship between the absorbance at 3007 cm^{-1} and the concentration of $\text{H-C}_6\text{F}_{13}$ in C_6F_{14} ; (reference purified PF 5060). Recommended for use at concentrations higher as 50 ppm.

It should be noticed that the interference with the hexane peak (see Fig. 18) can be solved by the activated carbon treatment: when the alkanes are quantitatively removed, the H-substituted perfluoroalkanes are only partly removed (Fig. 19). The GC methods are able to detect $\text{H-C}_6\text{F}_{13}$ without hexane interference (see Ch. 4.2.2.).

If we take into account that every C-H bond can lead by radiation induced scission to one HF molecule, it result that one $\text{H-C}_6\text{F}_{13}$ molecule will produce 14 times less HF than one hexane molecule. If we take into account also the molecular weight ratio Hexane/ $\text{H-C}_6\text{F}_{13}$ = 86/320, it result that the same quantity of HF produced by 1 ppm of hexane will be produced by 52 ppm of $\text{H-C}_6\text{F}_{13}$. Therefore, the sensitivity of the method is appropriate in detecting the imposed levels of detrimental H-containing molecules. Generally speaking, the different types of H-containing molecules existing as impurities in perfluorocarbon fluids will show quite similar IR absorption shape within the spectral area located around 3000 cm^{-1} . It is hence rationally to express the result in equivalent of hexane content, based on the hexane calibration curve. If necessary, other techniques can be applied to identify the exact chemical nature of impurities and to quantify them.

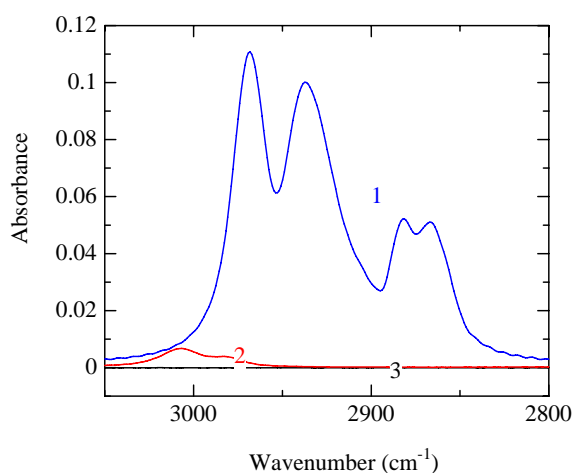

Fig. 18 – FT-IR spectra in region of 3000 cm^{-1} of purified PF 5060 containing 500 ppm of hexane (1) and 2000 ppm of $\text{H-C}_6\text{F}_{13}$ (2); reference purified PF 5060 (3).

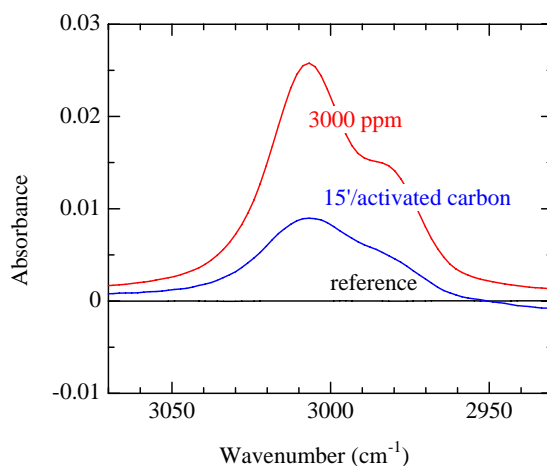

Fig. 19 – FT-IR spectra in the region of 3000 cm^{-1} of purified PF 5060 containing 3000 ppm H-C₆F₁₃, before and after treatment with activated carbon (15% Fluka 39988); reference purified PF 5060.

In conclusion, the FT-IR spectroscopy is adequate for the detection and dosage of H-containing molecules and a procedure based on this method was developed. The UV-Vis spectrophotometry and the GC methods are also useful methods to identify the eventual presence of H-substituted perfluoroalkanes.

Among the C₆F₁₄ fluids received in CERN, PF 5060 DL and PP1 are compliant to CERN quality requirements concerning the hydrogen containing molecules. The fluid PF 5060 contains about 700 ppm of such molecules and doesn't meet these requirements. An appropriate purification can, presumably, drastically reduce their level.

4.2.2 GC methods

4.2.2.1 GC-TCD

The presence of the H-containing molecules can be evidenced by GC methods as it was already shown in Tables 7 and 8. Alkanes (hexane) can be detected in GC-TCD analysis as a peak at r.t.⁴ = 47.75 min. (with method PFC 2006B) and at r.t. = 68 minutes (with method PFC 2006C). In both cases, it appears at r.t. = 48.10 min.⁵ and r.t. = 73 min., respectively (Fig. 20)⁶. The resolution is improved in the latter case. The detection limit is around 100 ppm.

⁴ r.t. = retention time

⁵ This peak was either very weak or was not observed in the chromatograms of DL

⁶ See Ch. 4.1. for the peaks assignments.

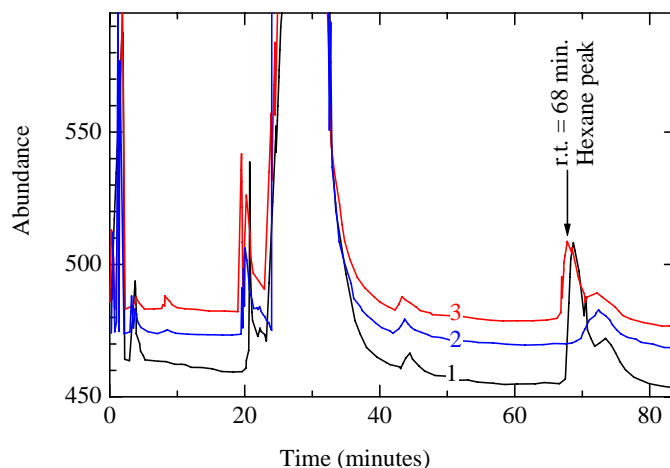

Fig. 20. – Hexane peak in C_6F_{14} analyzed by GC-TCD (PFC 2006C): 1 - purified PF 5060 + 1000 ppm of hexane; 2 - purified PF 5060; 3 - PF 5060.

The results on the hexane content obtained by GC-TCD method, performed on the studied C_6F_{14} fluids, are summarized in Table 11. To calculate the concentration of hexane, it was used a calibration curve (a straight line) obtained by the *percent area* of the peak at r.t. = 68 minutes (method PFC 2006C) as a function of the hexane concentration in various C_6H_{14}/C_6F_{14} samples. The area percent was calculated as the ratio of the *peak area at r.t. = 68 minutes / total peak areas* resulted from integration. The calibration curve is shown in Fig. 21.

The values found for the concentration of the alkanes (hexane) in PF 5060 and FC-72 are very close to those found by FT-IR spectroscopy (see Table 9). No alkanes (hexane) were observed in PP1, PF 5060 DL or purified PF 5060.

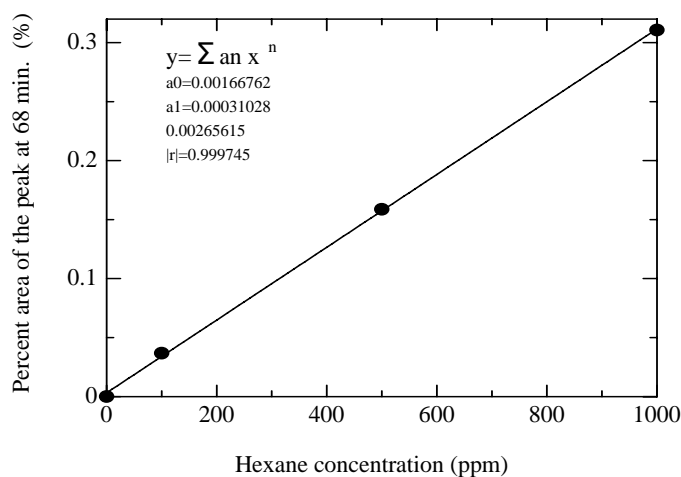

Fig. 21 – The calibration curve for C_6H_{14} content by GC-TCD (method PFC 2006C)

Table 11 – Hexane content in the studied perfluoroalkanes determined by GC-TCD (method PFC 2006C)

Code	Sample	Percent area of the peak at 68 min. (%)	Hexane (ppm)	Average (ppm)
73	PF 5060	0.1660	531	615
68		0.2178	698	
75	purified PF 5060	no peak	none detectable	no detectable
61		no peak	none detectable	
70	PF 5060 DL	no peak	none detectable	no detectable
72		no peak	none detectable	
62	PP1	no peak	none detectable	no detectable
74		no peak	none detectable	
77	FC-72	0.1354	432	375
80		0.0997	317	

It can be observed that the concentration of hexane in PF 5060 and FC-72 are very high as compared to the CERN imposed maximum limit of 10 ppm.

H-substituted perfluoroalkanes, as H-C₆F₁₃, were eluted before hexane. In the case of H-C₆F₁₃, the corresponding r.t. values were 35.4 minutes, with the method PFC 2006 B and ca. 47 min. with the method PFC 2006C. The detection limit is below 50 ppm and no interference with hexane occurred in GC-TCD. The calibration curve was obtained using various H-C₆F₁₃ solutions (Fig. 22).

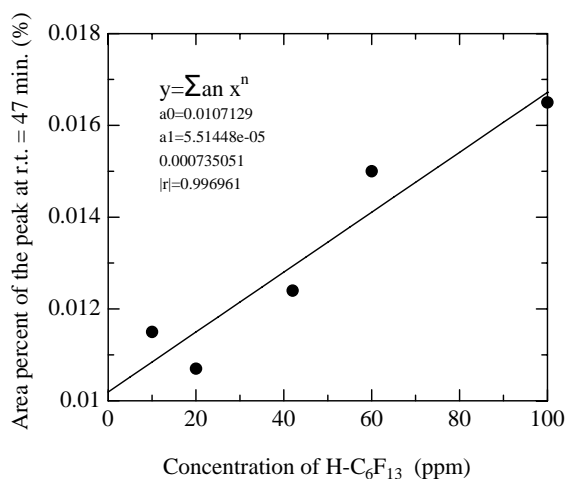

Fig. 22 – The calibration curve for H-C₆F₁₃ content by GC-TCD (method PFC 2006C)

The results on the H-substituted content obtained by GC-TCD method, performed on the studied C₆F₁₄ fluids, are summarized in Table 12. No H-substituted perfluoroalkanes were detected, the results being in good agreement with the FT-IR spectroscopy data. Therefore, it can be said that the observed H-containing molecules consist mainly in hexane.

Table 12 – H-substituted perfluoroalkanes content in the studied perfluoroalkanes

Code	Sample	Percent area of the peak at 47 min. (%)	H-C ₆ F ₁₃ content (ppm)
73	PF 5060	0.0036	below the detection limit
68		no peak	no detectable
75	purified PF 5060	0.0026	below the detection limit
61		0.0023	“
70	PF 5060 DL	no peak	no detectable
72		“	“
62	PP1	no peak	no detectable
74		“	“
77	FC-72	no peak	no detectable
80		“	“

In conclusion,

- GC-TCD confirmed the conclusions of FT-IR spectroscopy measurements regarding the existence of H-containing molecules in the C₆F₁₄ fluids as received in CERN; the observed H-containing molecules consist mainly in hexane.

- GC-TCD can provide information on the nature of the eventual alkanes present.

4.2.2.2 GC-MSD

The presence of the H-containing molecules can be evidenced by GC-MSD method. The peak of hexane was very clear and no neighboring peaks or shoulders were observed (see Fig. 2 and Table 7). The detection limit was well below 30 ppm (at 30 ppm a small peak is still clearly observed, as is shown in Fig. 23).

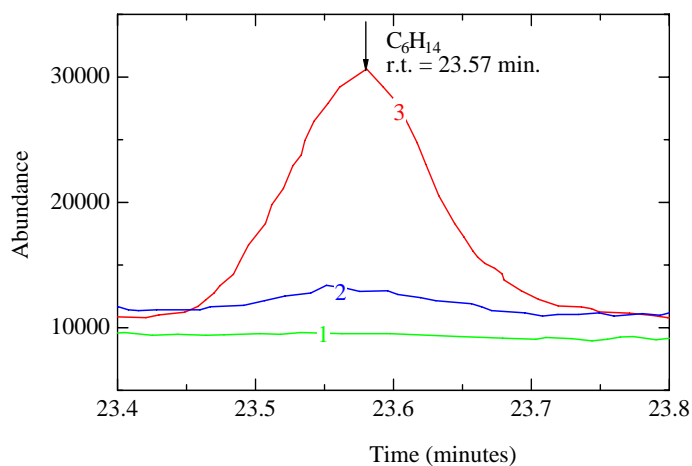

Fig. 23 – Hexane peak in C₆F₁₄ solutions: 1 - purified PF 5060; 2 - 30 ppm; 3 - 300 ppm. The sensitivity of the method is remarkable, owing the recorded abundance of the main peak (n-C₆F₁₄): ca. 2.3·10⁷.

The calibration curve of the hexane concentration was obtained in a similar manner as described in the case of GC-TCD (Fig. 24). The concentration of hexane in the studied C₆F₁₄ fluids was then evaluated, the results being summarized in the Table 13. The results and the conclusions are consistent to those of FT-IR spectroscopy, UV-Vis spectrophotometry, as well as GC-TCD.

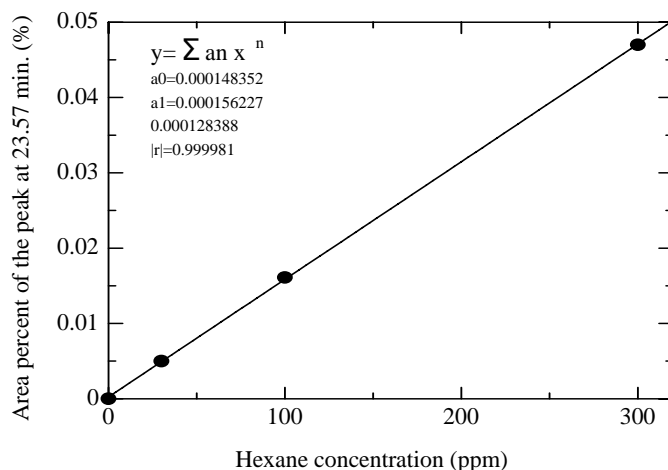

Fig. 24 – The GC-MSD calibration curve for C_6H_{14} content

Table 13 – Alkanes content (hexane) determined by GC-MSD in the studied perfluoroalkanes

Code	Sample	Percent area of the peak at 23.57 min. (%)	hexane content (ppm)	Average content (ppm)
38	PF 5060	0.059	541	553
42		0.067	631	
45		0.054	486	
37	purified PF 5060	no peak	-	-
46		no peak	-	
47	PF 5060 DL	0.0007*	-	-
48		0.0005*	-	
34	PP1	no peak	-	-
35		no peak	-	

*Very small peaks

It should be noticed that the relationship *abundance as a function of hexane concentration* was linear up to 300 ppm. The GC-MSD method is a useful method to detect the H-containing molecules, as well as to establish or to confirm their chemical nature.

The peak of $H-C_6F_{13}$ introduced as a control sample in purified PF 5060, with no H content, was observed at r.t. = 30.08 min. The peak is sharp, well resolved and is accompanied by several others (see Fig. 2), which can complicate the assignment at low concentrations. The detection limit is considered to be less as 30 ppm as it can be seen in the Fig. 25.

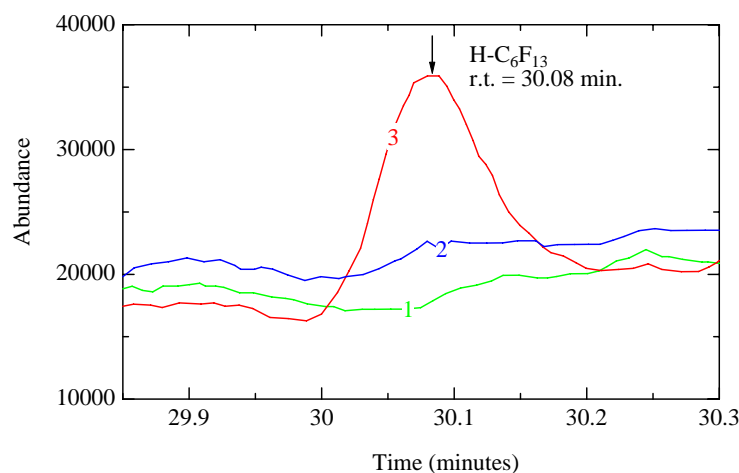

Fig. 25 – $H-C_6F_{13}$ identification: 1 - purified PF 5060; 2 - 30 ppm; 3 - 300 ppm. The abundance of the main peak of purified PF 5060 was $2.3 \cdot 10^7$.

No peaks at r.t. values corresponding to the H-C₆F₁₃ were observed for the other C₆F₁₄ analyzed fluids (PF 5060, PF 5060 DL, PP1 and purified PF 5060). These results are consistent to those provided by GC-TCD method.

It can be concluded that GC methods are sensitive to the presence of the H-containing molecules, both alkanes and H-substituted perfluoroalkanes. The GC-MSD method is more sensitive than GC-TCD. The GC-TCD method can identify and quantify the H-C₆F₁₃ or similar molecules in the presence of hexane, being useful in the analysis of the various types of H-containing molecules impurities. The PF 5060 fluid contained 550 ppm hexane. In PP1, PF 5060 DL and the purified PF 5060 the H-substituted perfluoroalkanes (such as H-C₆F₁₃) and hexane are below the detection limit of the GC methods.

4.3 Detection and dosage of the double bond containing molecules

The double bond containing molecules are undesirable products because they can lead under irradiation to oligomers and polymers, which can stop up the small cooling channels and orifices. The unsaturated molecules can originate either in the dimer of the perfluoropropylene (an intermediate step in the synthesis of the perfluoroisohexane at F2) or in catalytic dehydrofluorination of some H-substituted perfluorohexanes (in the case of 3M). In both cases, the most likely compounds are perfluorinated alkenes.

4.3.1 UV-Vis method

UV-Vis spectra of C₆F₁₄ around 200 nm were reported to be sensitive to the presence of different impurities, such as double bonds and even H-containing fluorocarbons [6]. Hence, having the experimental confirmation, the UV-Vis spectrophotometry was used as a testing method of the perfluorocarbons.

The experiments refer to the following objectives:

- Realization of a calibration curve of the optical absorbance as a function of double bonds content.
- Checking if the observed absorption in the FT-IR spectrum of PP1 is related to a possible high double bond content or it is caused by other factors (such as molecular absorptions of iso-C₆F₁₄)
- Evaluation of the double bonds content of the fluids received in CERN
- Study the effect of the various treatments applied to the fluids on the double bonds content via the UV-Vis spectra.

The UV spectra of the C₆F₁₄ fluids received in CERN (reference: air) are shown in Fig. 26. All fluids exhibit certain absorption starting at 190 nm, especially for FC-72. This absorption decreases steadily, becoming more transparent than the air at ca. 220 nm. This behavior is quite different to that described in ancient literature references, which reported an absorption peak at 220 nm in the case of impure perfluorocarbons [6] and can be related to different purities of the analyzed fluids. Therefore we concluded, on a hand, that the studied fluids are relatively pure and, on the other hand, we proposed to use the absorbance at 195 nm to characterize the double bonds content. C₆F₁₂ (n-1-perfluorohexene) was used as controlled double bond containing impurity. The spectra of the C₆F₁₄ samples containing different concentrations of controlled impurities as shown in Fig. 27. confirm the above mentioned absorption at 190 - 200 nm and can be related to the double bond content. The absorption at 195 nm was used to obtain the calibration curve (Fig. 28a. and Fig. 28b). Hence the UV spectrophotometry was applied to evaluate the concentration of the double bonds within the analyzed fluids (Table 14). The detection limit of the method is less than 2.5 ppm of C₆F₁₂. It

should be noticed that no significant absorption was observed at longer wavelengths (i.e. 220 nm) even for highly impurified samples (see Fig. 27).

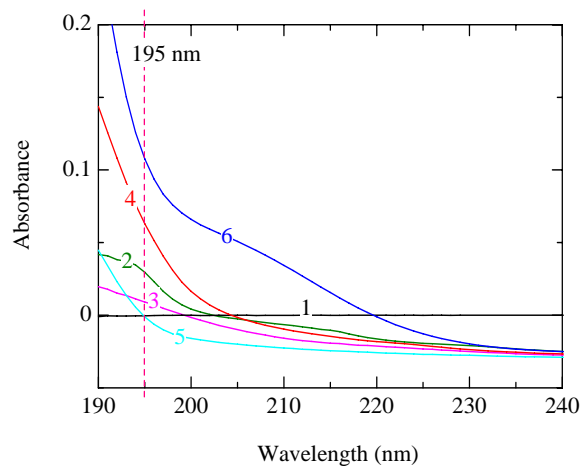

Fig. 26 – UV-Vis spectra of the C_6F_{14} fluids: 1 – reference air; 2 – PPI; 3 – PF 5060 DL; 4 – PF 5060; 5 – purified PF 5060; 6 – FC-72.

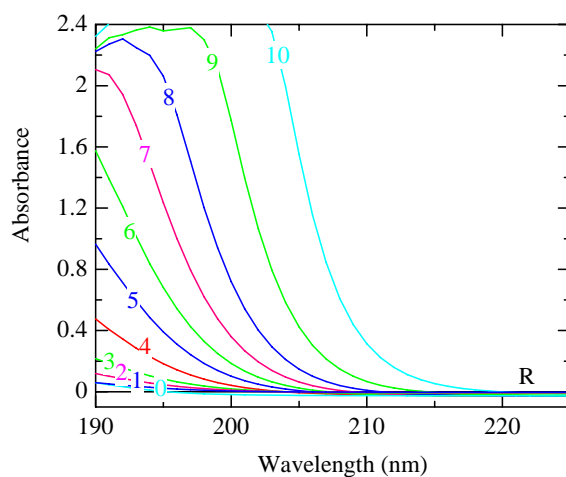

Fig. 27 - UV spectra around 200 nm of purified PF 5060, containing known concentrations of C_6F_{12} : R - air reference; 0 - purified PF 5060; 1 - 2.5 ppm; 2 - 5 ppm; 3 - 10 ppm; 4 - 20 ppm; 5 - 50 ppm; 6 - 100 ppm; 7 - 200 ppm; 8 - 400 ppm; 9 - 1000 ppm; 10 - 1900 ppm.

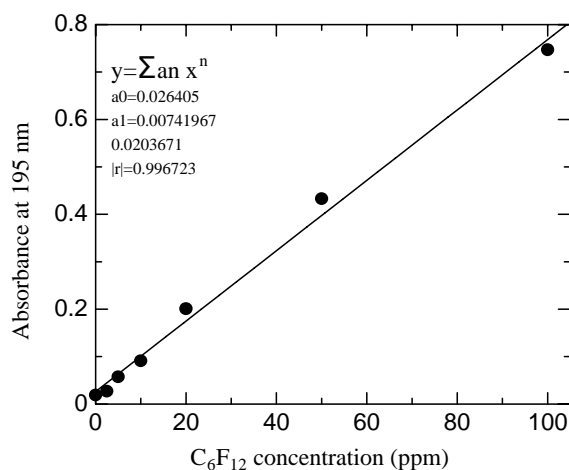

Fig. 28a – The calibration curve of the optical absorbance at 195 nm as a function of C_6F_{12} concentration in C_6F_{14} fluids.

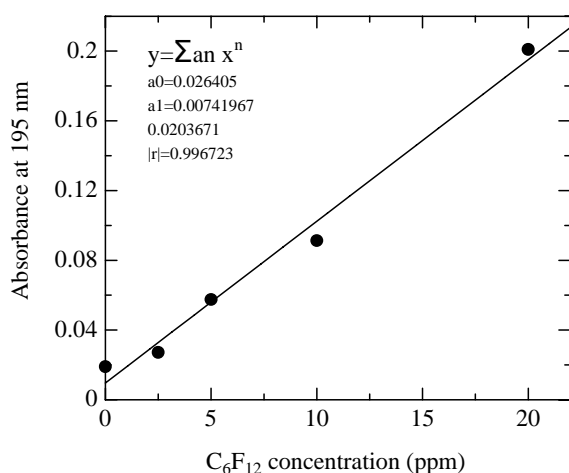

Fig. 28b – Detail of the first part of the calibration curve of the optical absorbance at 195 nm as a function of C_6F_{12} concentration in C_6F_{14} fluids.

Table 14 – The optical absorbance at 195 nm and the equivalent concentration of the double bonds in the studied fluids

Sample	Absorbance at 195 nm	Equivalent double bond content (ppm)	Average value (ppm)	Conclusion
PF 5060	0.062844	4.9	4.9	Test passed
	0.061718	4.8		
Purified PF 5060	0.019023	-	- (undetectable)	Test passed
	0.015975	-		
PF 5060 DL	0.032218	0.8	0.6 (under the detection limit)	Test passed
	0.029371	0.4		
PP1	0.048934	3.0	1.7 (under the detection limit)	Test passed
	0.029469	0.4		
FC-72	0.105042	10.6	10.6	Test not passed
	0.104083	10.5		

Similar results were obtained in another series of experiments, when PP1 fluid was used to prepare the controlled C_6F_{12} impurified solutions (Fig. 29).

However, the absorbance observed in the UV spectra could be also due to various other impurities (such as hydrocarbons, H-substituted perfluoroalkanes, mineral oils and greases), not exclusively to double bonds. Therefore, in Table 14, are presented the values of the *equivalent double bonds concentrations* (considering that all observed absorption is due to the double bonds). A good illustration is the case of PF 5060 which exhibited an absorbance corresponding to ca. 5 ppm of double bonds. This absorbance decreased significantly after a treatment with activated carbon (see Fig. 26, curves 4 and 5), indicating the occurrence of H-containing molecules⁷. In fact, not only the alkanes or the H-substituted perfluoroalkanes, but also the greases can induce increased absorption in this region (see Figs. 30 and 31). When the activated carbon treatment (which removes the H-containing molecules) was applied, these absorptions were diminished (see Figs. 26, 30 and 31), while the absorption induced by n-perfluorohexene (C_6F_{12}) remained quite constant (Fig. 32).

For these reasons, the following procedure to analyze the perfluorocarbon fluids is proposed:

- A first investigation by UV-Vis of the fluid absorbance at 195 nm:
 - if the optical absorbance is smaller than the value corresponding for the maximum accepted double bonds content (i.e. 0.100 absorbance units, measured in a cell with an optical path of 1 cm), the test is passed;
 - if the absorbance is greater than the value corresponding for maximum accepted double bonds content (i.e. 0.100 absorbance units, measured in a cell with an optical path of 1 cm), a treatment with activated carbon is applied. (The treatment with activated carbon was made using a cartridge of 25 cm length and 1 cm inner diameter filled with activated carbon (a mixture ratio of 1:1 of Fluka 29204/Fluka 29238⁸);
- A second UV analysis will check again the absorbance at 195 nm;
 - if no decreasing in the absorbance at 195 nm is observed, the presence of double bonds is certain and their dosage will be made on the basis of the calibration curve (Fig. 28).
 - if the optical absorbance is decreased, the presence of H-containing molecules is probable, and the FT-IR spectra in the region of $3100 - 2800 \text{ cm}^{-1}$ should be measured on both initial and treated samples; the concentration of H compounds is then evaluated by the FT-IR procedure established for H containing molecules.

⁷ Activated carbon treatment is no effective for double bonds containing molecules as it is shown below.

⁸ Fluka 29238 is an activated carbon impregnated with KOH. It should remove the acid components, such as H-substituted perfluoroalkanes.

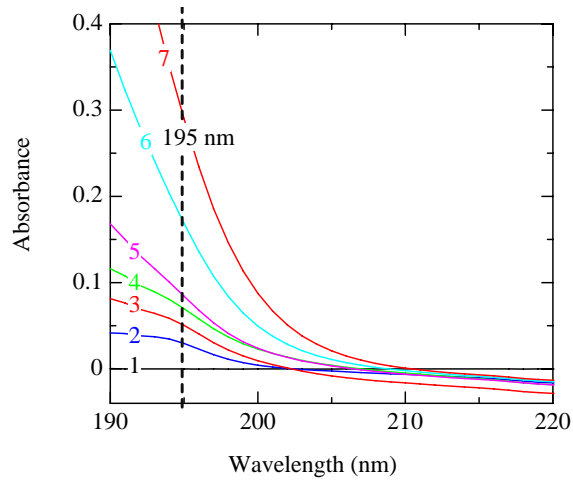

Fig. 29 – The optical absorbance at 195 nm of PPI samples containing various amounts of C₆F₁₂: 1 – reference air; 2 – PPI; 3 – 2.5 ppm; 4 – 5 ppm; 5 – 10 ppm; 6 – 25 ppm; 7 – 50 ppm.

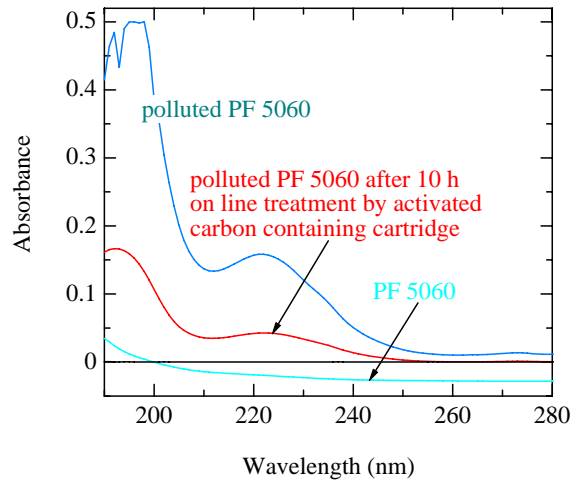

Fig. 30 – Example of the PF 5060 polluted with dioctyl phthalate [(C₈H₁₈)₂C₈H₆O₂] and the effect of the subsequent activated carbon treatment evidenced by UV-Vis method; reference air.

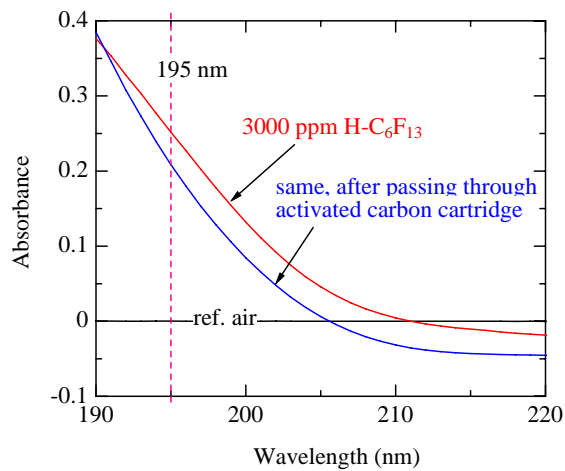

Fig. 31 – The effect of activated carbon treatment on the absorption of purified PF 5060 containing H-C₆F₁₃.

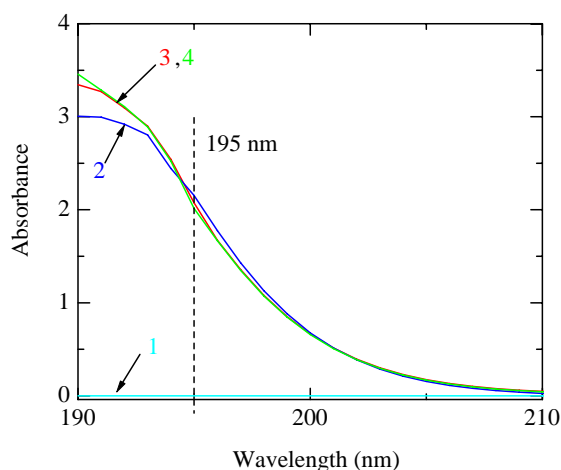

Fig. 32 – The effect of the activated carbon treatment on the UV spectra of the PP1 containing 500 ppm of C_6F_{12} : 1 – reference air; 2 – PP1 + 500 ppm C_6F_{12} ; 3 – PP1 + 500 ppm C_6F_{12} passed through a cartridge containing activated carbon; 4 – same as 3 after a supplementary passing.

Concerning the PP1 fluid, UV-Vis measurements proven undoubtedly that no any significant alkene amount is present (see Figs. 26, 29, 33, and Tab. 14): there is only a slight optical absorption of PP1 at 195 nm which corresponds to an amount of double bonds less as 2 ppm, *below the detection limit of the UV-Vis method*. To confirm the source of the observed absorption in the PP1 spectrum, this fluid was passed through an activated carbon cartridge and the spectra of the initial and treated samples (see Fig. 33) were compared. Only a small part of the absorption is due to other molecules - hydrogen containing ones - which are removed by the activated carbon, an effect similar to that observed in the case of PF 5060 DL or purified PF 5060. Therefore, it can be concluded that the double bond concentration in PP1 fluid is negligible.

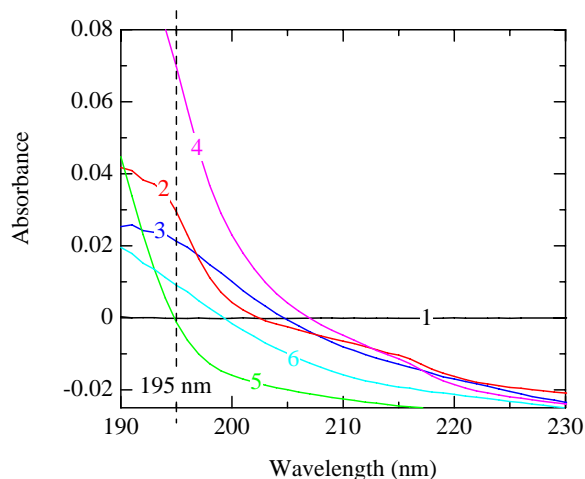

Fig. 33 – UV-Vis spectra of some perfluorocarbons: 1 - reference air; 2 - PP1 as received; 3 - PP1 treated with activated carbon; 4 - PP1 as received + 5 ppm C_6F_{12} ; 5 - purified PF 5060; 6 - PF 5060 DL as received.

Note: Concerning the PP1 fluid, it should be noticed that a relative intense optical absorption was observed in FT-IR spectrum (see below Ch. 4.3.3.) around that of the characteristic absorption of C_6F_{12} (i.e. 1784 cm^{-1}). Taking into account the differences in the shapes of C_6F_{12} and iso- C_6F_{14} FT-IR spectra, it was supposed that the observed absorption is specific to the iso- C_6F_{14} having as reference n - C_6F_{14} and it is not due to the double bond presence, as it was confirmed by the UV-Vis measurements.

4.3.2 GC-MS method

1-C₆F₁₂ (1 - perfluorohexene, named below C₆F₁₂) was used as control sample for detection and dosage of the double bonds in the studied C₆F₁₄ fluids.

GC-TCD method was not applicable because C₆F₁₂ was eluted, perhaps together with the main peak.

GC-MSD chromatograms for C₆F₁₂/ C₆F₁₄ solutions show a sharp peak at r.t. = 22.30 min. (with PERFLUORO D method⁹) and r.t. = 22.55 min. (with PERFLUORO E method). There is no peak near to C₆F₁₂ one in PP1 (Fig. 2), but a small peak (assigned to a homologous perfluorocarbon) is visible in PF 5060 samples at r.t. = 22.18 (PERFLUORO D) or 22.36 (PERFLUORO E). This peak can create difficulties in the analysis of C₆F₁₄ samples containing low amounts of C₆F₁₂. Several very small peaks were also observed in the case of PF 5060 DL in the region of 22 - 23 minutes, but no peak at 22.55 min. Therefore, the detection limit was considered to be around 30 ppm (below it). At this concentration, the C₆F₁₂ peak is still discerned (Fig. 34).

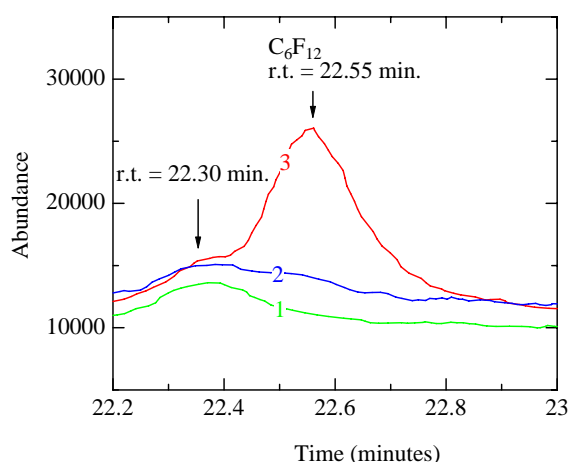

Fig. 34 – The peak at r.t. 22.55 min. of purified PF 5060 containing different amounts of C₆F₁₂: 1 - purified PF 5060; 2 - 30 ppm C₆F₁₂; 3 - 300 ppm C₆F₁₂ (method PERFLUORO E).

The calibration curve (a straight line) was obtained by representation of the *percent area of the peak at 22.55 min.* as a function of C₆F₁₂ concentration (Fig. 35). No peak was observed at 22.55 min. for the studied liquids and it can be concluded that no double bonds containing molecules are present (or they are under the detection limit, see Table 15).

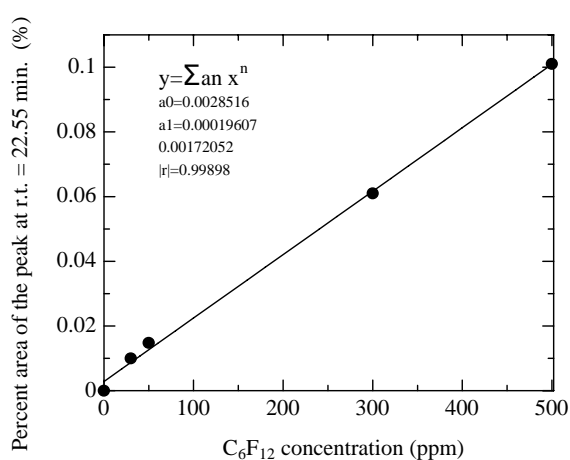

Fig. 35 – Calibration curve of the percent area of the peak at r.t. = 22.55 min. as a function of C₆F₁₂

⁹ See Ch. 3 for the working conditions in GC-MSD analysis

Table 15 – Double bonds content of the analyzed C₆F₁₄ fluids (PERFLUORO E method)

Code	Sample	Percent area of the peak at 22.54 min. (%)	C ₆ F ₁₂ content (ppm)	Comments
38	PF 5060	no peak*	below the detection limit	GC-MSD test passed
42		“	“	
45		“	“	
37	purified PF 5060	no peak*	below the detection limit	GC-MSD test passed
46		“	“	
47	PF 5060 DL	no peak*	below the detection limit	GC-MSD test passed
48		“	“	
34	PP1	no peak	no detectable	GC-MSD test passed
44		“	“	

* a very small peak at 22.36 min., attributable to a homologous perfluorocarbons of C₆F₁₄ was observed

The GC-MSD results are consistent with those provided by UV-Vis spectrophotometry and FT-IR spectroscopy and (see Ch. 4.3.1 and 4.3.3).

GC-MSD is useful as a complementary test for UV-Vis spectrophotometry and FT-IR spectroscopy. This method can provide information about the existence of double bond containing molecules and can be used even for quantification at the concentration levels as higher as the detection limit (i.e. ca. 30 ppm).

4.3.3 FT-IR method

In hydrocarbon alkenes and similar compounds [7] the double bonds C=C exhibit a specific optical absorption around 1640 cm⁻¹. In the case of the fluorinated alkenes, this band is shifted to higher frequencies, at more than 1700 cm⁻¹ [8].

In the present work, we have taken 1-perfluorohexene (1-C₆F₁₂, called below C₆F₁₂) from ABCR as a model compound for the double bonds containing molecules, which could be eventually present in both PP1 and PF 5060.

All the perfluorocarbon fluids have a complex Infra Red spectrum structure if air is the reference. For example, as shown in Fig. 36, the FT-IR spectrum of PF 5060 DL, a pure product without double bonds exhibits a strong optical absorption in the region 1600 - 1800 cm⁻¹; similar spectra were observed in the case of both PF 5060 purified and PF 5060. If the main matrix is used as reference, the general shape of the spectra is simplified and the specific optical absorption due to double bonds presence became clearly visible and sensitive to their concentration, as illustrated in Fig. 37, curves 1, 2, and 3, with purified PF 5060 (n-C₆F₁₄) as reference. The curve 4 has a different shape due to the different structure of the PP1 fluid (iso-C₆F₁₄) measured by rapport to the reference, a purified PF 5060 (n-C₆F₁₄) fluid.

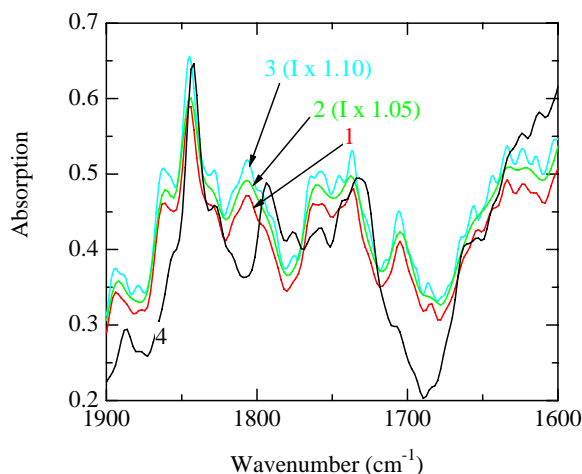

Fig. 36 – FT-IR spectra in the region of 1900 - 1600 cm^{-1} of some C_6F_{14} fluids: 1 - PF 5060; 2 - PF 5060 DL; 3 - purified PF 5060; 4 - PP1; reference air.

Controlled impurification of purified PF 5060¹⁰, by C_6F_{12} , revealed a main peak at 1785 cm^{-1} accompanied by several others at different frequencies: 1800 cm^{-1} , 1792 cm^{-1} , 1772 cm^{-1} , 1769 cm^{-1} , 1757 cm^{-1} , etc. (Fig. 37). The main peak at 1785 cm^{-1} can be related to the 1- C_6F_{12} , while others ones can be assigned to various other impurities [the main one is 2- C_6F_{12} (ca. 8%) which could be responsible for the peak at 1769 cm^{-1}]. The optical absorption at 1785 cm^{-1} was found to be linearly related to the concentration of the C_6F_{12} , as shown in Fig. 38.

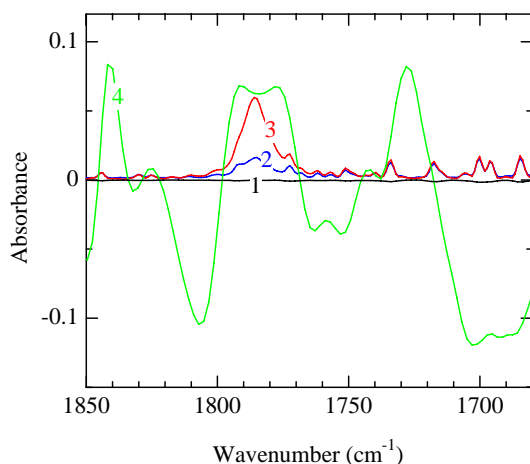

Fig. 37 – FT-IR spectrum of several C_6F_{14} samples: 1 - reference purified PF 5060; 2 - purified PF 5060 + 100 ppm of C_6F_{12} ; 3 - purified PF 5060 + 500 ppm of C_6F_{12} ; 4 - PP1.

In the case of PP1 fluid, its composition consists in perfluoro-2-methylpentane (iso- C_6F_{14}), hence this type of fluid must be used as FT-IR reference for the measurement of its double bonds content. Owing that no double bonds were detected in the PP1 sample received in CERN by UV-Vis or GC methods, which are sensitive towards this type of impurity, it was taken as a reference for the analyses of this type of fluids. The effect of controlled amounts of C_6F_{12} on the optical absorbance at 1785 cm^{-1} of PP1 (iso- C_6F_{14}) is shown in Fig. 39. and the obtained calibration curves are shown in Fig. 40a and in Fig. 40b. The detection limit was found similar to that of C_6F_{12} present in purified PF 5060 (n- C_6F_{14}), i.e. 2.5 ppm.

¹⁰ See Ch. 4.2.1. for information about the purification

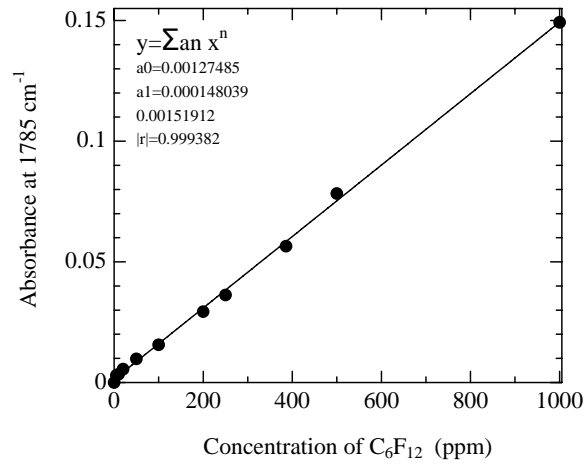

Fig. 38 – The calibration curve of the FT- IR optical absorbance at 1785 cm⁻¹ as a function of C₆F₁₂ concentration in n-C₆F₁₄. Reference: purified PF 5060 (n- C₆F₁₄).

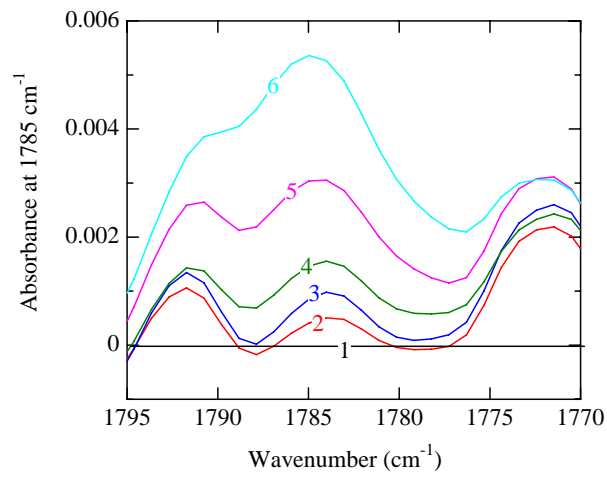

Fig. 39 – The optical absorbance at 1785 cm⁻¹ of the PP1 (iso-C₆F₁₄) containing various amounts of C₆F₁₂: 1 - Reference: PP1 (iso-C₆F₁₄); 2 - 2.5 ppm; 3 - 5 ppm; 4 - 10 ppm; 5 - 25 ppm; 6 - 50 ppm.

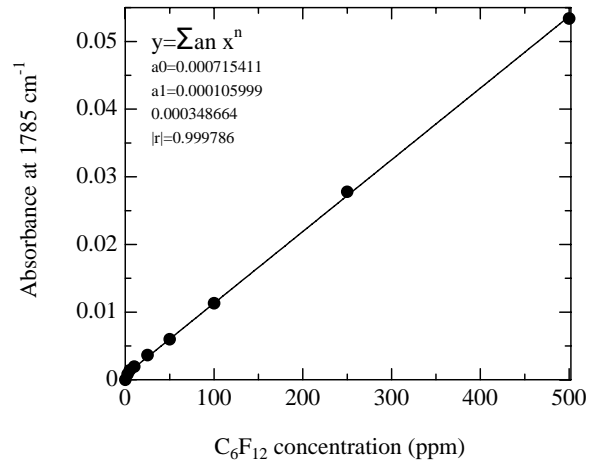

Fig. 40a – The calibration curve of the FT- IR optical absorbance at 1785 cm⁻¹ as a function of C₆F₁₂ concentration in PPI fluid (iso-C₆F₁₄). Reference: PPI (iso-C₆F₁₄).

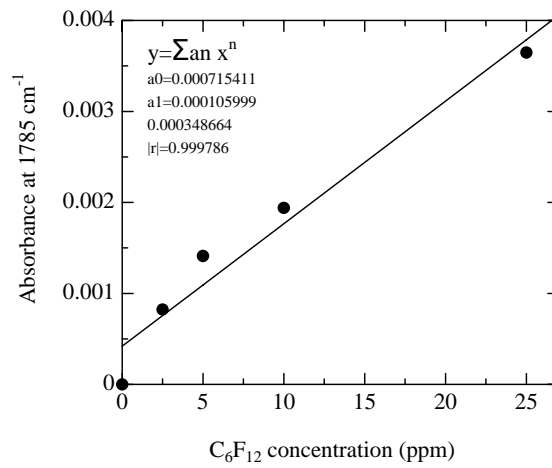

Fig. 40b – Detail of the calibration curve of the FT- IR optical absorbance at 1785 cm⁻¹ as a function of C₆F₁₂ concentration in PPI fluid (iso-C₆F₁₄). Reference: PPI (iso-C₆F₁₄).

4.4 KMnO_4 test for the reducing agents

Potassium permanganate (KMnO_4) is well known to produce the oxidation of the double bonds containing hydrocarbons; therefore it could be a useful test for detection of double bonds containing molecules. F2 - Chemicals proposed a method (FC-40-116) for determination of the reducing agents, e.g. double bonds in the perfluorocarbon fluids based on KMnO_4 oxidation [9]. The test is based on the visual observation of the initial KMnO_4 solution discoloration or on the appearance of a precipitate.

In this work, we checked the effectiveness of the method to detect the perfluoroalkene (double bonds containing perfluorinated molecules). The recommended procedure of F2-Chemicals was applied to various C_6F_{14} fluids. Thus, the following steps were realized:

- preparation of a KMnO_4 solution (FC-40-116): 0.040 g of KMnO_4 (pro analysis grade) was introduced in a 25 mL aliquot and acetone was added to reach 25 mL volume; then, the mixture was shaken to obtain a clear solution;
- 10 mL of the C_6F_{14} sample under test were pipetted into a 25 mL aliquot; 1 mL of the acetone/ KMnO_4 solution was then added and the resultant mixture was shaken for 20 minutes;
- after the separation of the two layers, the upper permanganate layer was examined for signs of a precipitate or for a color fading .

No changing in the color was observed with PP1, PF 5060 DL or purified PF 5060. Slight modification was observed in the case of PF 5060, and this can be assigned to oxidation of hexane or similar H-containing molecules.

Then, a solution of 1-perfluorohexene (C_6F_{12}) in C_6F_{14} was analyzed. Several experiments were made using purified PF 5060 and PP1 as solvents. Because no any visible changes in the color were observed, the treated perfluorocarbon solutions were investigated further by UV-Vis and FT-IR spectroscopy, after the separation of the KMnO_4 / acetone layer. No changes in the optical absorption of the perfluoroalkene characteristic peaks were detected using both methods, even the oxidation conditions were varied from the soft (in the neutral solution, as recommended) to the most energetic ones (in acid solutions) as it can be seen in Figs 41 and 42. The result is in agreement with the GC results and the literature data as well (which indicate different agents and conditions for the perfluoroalkene oxidation [10, 11]).

It can be concluded that the KMnO_4 test method (FC-40-116) is not enough sensitive to the detection of trace amounts of the double bonds containing molecules and should not to be used for this application.

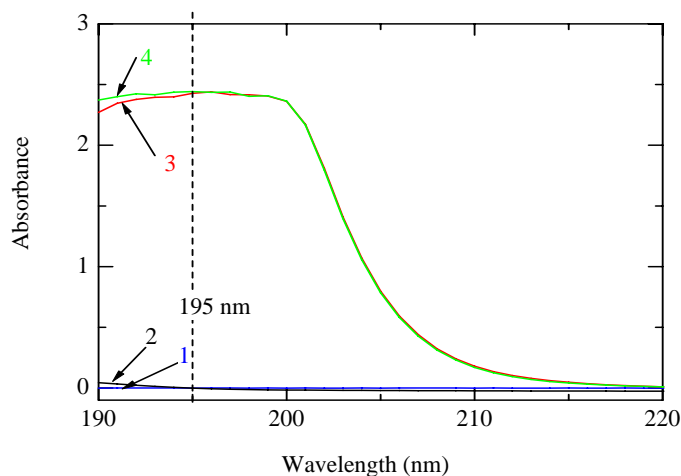

Fig. 41 – KMnO_4 treatment effect on the C_6F_{12} contained in purified PF 5060: 1 - reference air; 2 - purified PF 5060; 1900 ppm; 3 - 1900 ppm after KMnO_4 treatment.

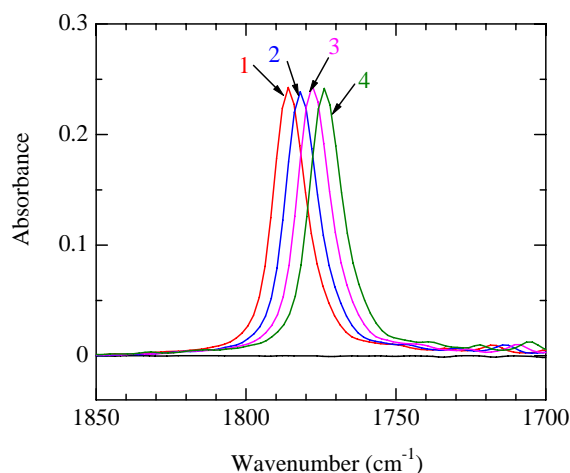

Fig. 42 – The permanganate treatment has no effect on the C_6F_{12} content in C_6F_{14} (purified PF 5060) as evidenced by FT-IR spectra in the region of 1780 cm^{-1} (reference purified PF 5060):
 1 - C_6F_{12} (1900 ppm in C_6F_{14}) initial; 2 - C_6F_{12} (1900 ppm in C_6F_{14}) treated by neutral solution of KM_nO_4 ; 3 - C_6F_{12} (1900 ppm in C_6F_{14}), initial (re-recorded the initial sample); 4 - C_6F_{12} (1900 ppm in C_6F_{14}) treated by acid¹¹ solution of KM_nO_4 (the spectra were right shifted for a better viewing).

4.5 Measurements of the free fluoride (HF)

The calibration curve was obtained using standard NaF solutions (Fig. 43).

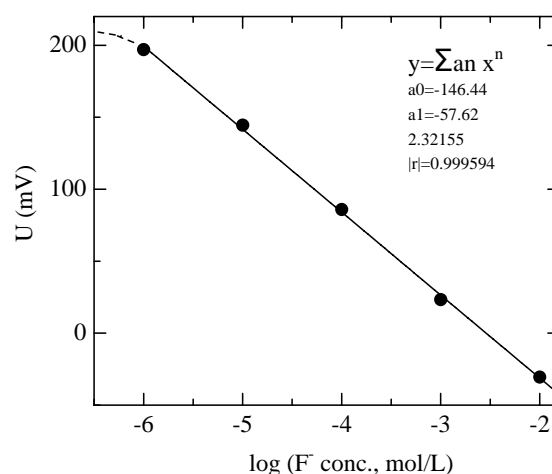

Fig. 43 – The calibration curve of the voltage of F^- ion selective electrode as a function of the F^- ions concentration.

HF potentially contained in C_6F_{14} fluids was quantitatively converted to fluoride ions using a KOH solution ($HF + KOH = KF + H_2O$). Thus, an amount of approx. 12 - 15 g, accurately weighed, was shaken with $30 - 40\text{ cm}^3$ of a potassium hydroxide solution (1.2 g KOH / L)¹² and the aqueous solution containing the fluoride ions was analyzed. A precise measured weight and volume of gaseous C_3F_8 was bubbled through the KOH solution. To the solution resulted from the absorption process, which contains KF, were added 10 cm^3 of TISAB III and water up to 100 cm^3 .

¹¹ Acid solution (50 mL) was prepared by mixing 0.08 g $KMnO_4$ with pure H_2O and 8 mL of solution H_2SO_4 20%; then, 10 mL of this solution was used as indicated the procedure.

¹² A plastic bottle of 100 cm^3 was used to take-out the C_6F_{14} sample and to shake its mixture with KOH solution.

In both cases (C_6F_{14} and C_3F_8) the quantity of the hydrofluoric acid (HF) was calculated from the F^- concentration using the formula:

$$w_{HF} = C_{F^-} \times V \times M_{HF} \quad (3)$$

where:

w_{HF} is the weight of HF,

C_{F^-} is the concentration of the fluoride ions as found by potentiometric method (mol/L),

V is the volume of the solution analyzed by potentiometric method (0.1 L),

M_{HF} is the molecular weight of HF (20 g/mol).

The concentration of the HF in the analyzed perfluorocarbons (C_{HF}) was calculated with the formula:

$$C_{HF} \text{ (ppm)} = \frac{w_{HF}}{W_{PFC}} \cdot 10^6 \quad (4)$$

where W_{PFC} is the weight of the analyzed perfluorocarbon fluid.

The detection limit for HF is < 0.01 ppm.

The results shown in Table 16 confirm that all perfluorocarbon fluids received meet the CERN quality requirements for the free fluoride concentration: its content was below the detection limit in all cases.

Table 16 – HF content of the perfluorocarbon fluids as received in CERN

Sample	Sample weight (W_{PFC} , g)	C_{KF} (mol/L)	w_{HF} (g)	C_{HF} (ppm)	Comments
PF 5060	83.53	$1.22 \cdot 10^{-6}$	$2.44 \cdot 10^{-6}$	0.03	Passed HF test
	12.55	$3.75 \cdot 10^{-7}$	$0.75 \cdot 10^{-6}$	0.06	
purified PF 5060	11.72	$1.17 \cdot 10^{-7}$	$2.34 \cdot 10^{-7}$	0.02	Passed HF test
PF 5060 DL	12.49	$2.1 \cdot 10^{-7}$	$4.2 \cdot 10^{-7}$	0.03	Passed HF test
PP1	11.82	$3.14 \cdot 10^{-7}$	$6.28 \cdot 10^{-7}$	0.05	Passed HF test
C_3F_8	12.12	$4.7 \cdot 10^{-7}$	$9.4 \cdot 10^{-7}$	0.08	Passed HF test

The present method will be used also to quantify the hydrofluoric acid appeared in the irradiated perfluorocarbon fluids as well as to assess the efficiency of their purification treatment.

4.6 Measurements of the boiling points (distillation ranges)

The distillation ranges of the following perfluorocarbon fluids were measured: PP1, PF 5060 and PF 5060 DL.

a) The results concerning **PP1** fluid are presented in Table 17 and the distillation curve is shown in Fig. 44

Table 17 – Distillation data for PP1 fluid

Temperature (°C)	Cumulated volume (mL)	ΔV (mL)	Comments
28.5-28.7	0.21	0.21	T < 51 °C; 0.67 mL, i.e. 0.67%
31.2	0.31	0.10	
33.5	0.62	0.31	
41.3	0.67	0.05	
53.0	0.69	0.02	
53.6	0.82	0.13	in the range 51 - 59 °C, distilled 98.96% of the liquid
54.5	0.98	0.16	
55.2	2.01	1.03	
55.6	4.64	2.63	
56.4	12.05	7.41	
57.0	99.48	87.43	
> 67 °C (Residue)	0.52	0.52	0.52% residue

Observations:

- The time of the process was 5.5 h;
- The main fraction (55-57 °C, 98.9 cm³) distilled in ca. 120 minutes;
- The first drop formed on the thermometer head was recorded at 31.2 °C (bath temperature 61.2 °C), but a small volatile fraction was already collected at lower temperatures (starting from 28 °C);
- 98.5 % of the sample distilled in the range 55 °C - 57 °C: the fluid **is conform to the CERN quality requirements regarding the boiling point** (i.e. b.p. = 51 °C- 59 °C) [12]; the result is in agreement also to that specified in the supplier certificate of analysis and to the literature data, as well [13]. The differences (of less than 1 °C) could be related to both the local atmospheric pressure and the altitude (ca. 340 m for Geneva area).

b) The results concerning **PF 5060** are presented in Table 18 and the distillation curve is shown in Fig. 44.

Table 18 – The distillation data of PF 5060

Temperature (°C)	Cumulated volume (mL)	ΔV (mL)	Comments
27.0	0.10	0.10	Separated as a first fraction (up to 28 °C)
27.2	0.19	0.09	
27.3	0.20	0.01	
27.4	0.33	0.13	
27.5	0.40	0.27	
27.6	0.41	0.01	
27.7	0.47	0.06	
28.0	0.60	0.13	
28.4	0.65	0.05	
29.0	0.67	0.02	
30.5	0.69	0.02	
32.6	0.75	0.06	
35.0	0.80	0.05	
37.0	0.89	0.09	
39.5	0.98	0.09	
41.0	2.19	1.21	II nd fraction (28 °C - 41 °C)
44.0	2.88	0.69	
45-46	3.60	0.72	
48.8	3.83	0.23	
51.3	5.86	2.03	III rd fraction (41 °C - 51.3 °C)
55.0	6.26	0.40	
56.8 - 57.0	99.04	92.78	
Residue	0.96	0.96	Not distilled up to 65 °C

Observations:

- The distillation was realized in 5.45 h,
- The main fraction (55°C - 57 °C) distilled in 125 min.

- This sample was divided in three light fractions, which distilled up to 28 °C, between 28 °C - 41 °C and between 41 °C - 51.3 °C respectively. The first fraction could correspond to perfluoropentane (C₅F₁₂, b.p. = 29 °C) and the second could contain perfluorodimethyl cyclobutane (b.p. 45 °C) and/or perfluoromethylcyclopentane (b.p. 48 °C) - see the b.p values of several perfluorinated compounds in the note below. The composition of the third fraction could contain hexane (around 1%) and C₆F₁₄ (more than 96 %), as identified by GC-TCD method also in the fraction II.

- Taking into account that 92.78 % of the product distilled in the range 55 °C - 57 °C, it can be considered 56 °C the boiling temperature. On the other hand, the results are in good agreement to the literature data which indicate a boiling point of 56 °C [14]. Based on these data, it can be considered that **the product meet the CERN requirements regarding the boiling point** [15] and is conform to the Certificate of Compliance delivered by the producer [16].

c) **PF 5060 DL** distillation data are presented in Table 19 and the corresponding distillation curve is shown in Fig. 44.

Table 19 – Distillation data of the PF 5060 DL

Temperature (°C)	Cumulated volume (mL)	ΔV (mL)	Comments
26.3	0.10	0.10	No true distillation observed; a small amount of liquid condenses in the receiving bottle
26.8	0.21	0.11	
27.0	0.23	0.02	Boiling started on the surface of the molecular sieves grains
27.2	0.29	0.06	
27.3	0.36	0.07	
45.0	0.37	0.01	
50.0	0.38	0.01	
54.0	7.25	6.87	In the range of 54 - 56.8 °C, distilled 98.46 % of the initial PF 5060 DL
56.8	98.84	91.59	
Residue	1.16	1.16	Not distilled up to 65 °C

Observations:

- The distillation was realized in 5.1 h;
- The main fraction (54 - 56.8 °C, 98.46 cm³) distilled in ca. 140 minutes; a relative long time was need to distill the end part of the fraction, when the distillation rate decreased and, as a result, the temperature tends to diminish;
- The first drop which was observed on the thermometer head at 28.4 °C; bath temperature 61 °C;
- Taking into account that 98.46 % of the initial sample distilled in the range 54.0 - 56.8 °C, the boiling point of the fluid is around 56 °C; thus, the PF 5060 DL fluid **is conform to the CERN quality requirements concerning the boiling point** [14];
- The result is also in agreement to data specified in the technical data sheet of the product [17], i.e. b.p = 56 °C;

The initial portions of the distillation curves shown in Fig. 44, as well as the data in Tables 17 to 19, suggest that the higher purity product is PF 5060 DL and the less pure one is PF 5060 (which exhibit many fractions between 27 and 56 °C). Anyway, three very small fractions (at 27 °C, at 45 °C and at 50 °C) are still visible in PF 5060 DL; another one, distilled at 54 °C was relatively important.

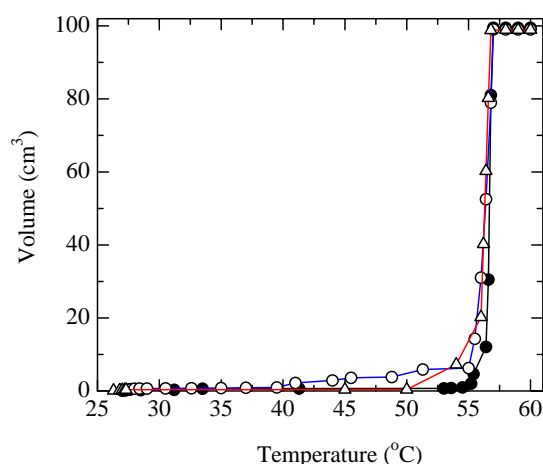

Fig. 44 – The distillation curves of the analyzed fluids: (●) PPI; (○) PF 5060; (Δ) PF 5060 DL

In conclusion, all the analyzed fluids exhibited narrow distillation ranges. The values are in agreement to the CERN requirements concerning the boiling point of these fluids.

Note: The boiling point values of several perfluorinated compounds possible present as impurities in the analyzed liquids.

Name	RN	B.p. (°C)/ Reference
Perfluoromethylcyclopentane (PCMP)	1805-22-7	48 [15]
Pefluoromethylcyclohexane (PCMH)	355-02-2	76 [15]
Pefluorobenzene	392-56-3	81-82 (at 743 torr) [15]
Perfluoro-dimethyl-cyclobutane	28677-00-1 2994-71-0	45 [15]
Perfluoro-methyl-cyclopentane	1805-22-7	48 [18]
Perfluorocyclohexane	355-68-0	59-60 [15]

4.7 Measurements of the density

The measured densities are presented in Table 20.

Table 20 – The measured densities values of perfluorocarbon fluids

PP1 (iso-C₆F₁₄)							
Pycnometer no.	$V (cm^3)^{13}$	w_i	w_f	$w_i - w_f$	$d_o = d_c (g/cm^3)$	Density (g/cm ³)	CERN req. value
33	50.6650	38.2668	125.209	86.9422	1.7160	1.721*	1.660 - 1.700
73	51.4177	26.8848	115.607	88.7222	1.7255		
73	51.4177	26.8448	115.296	88.4512	1.7202		
* The CERN imposed density value refers to <i>n</i> -C ₆ F ₁₄ ; the value found in literature for pure <i>perfluoro 2-methyl pentane (iso-C₆F₁₄)</i> is 1.723 [15]; that given by the supplier (F2) is 1.725 g/cm ³ [19]. Thus, the measured density value corresponds to a pure fluid.							
PF 5060 (n-C₆F₁₄)							
Pycnometer no.	$V (cm^3)$	w_i	w_f	$w_i - w_f$	$d_o = d_c (g/cm^3)$	Density (g/cm ³)	CERN req. value
73	51.4177	26.8448	113.719	86.8742	1.6896	1.6885	1.660- 1.700
33	50.6650	38.2668	123.765	85.4982	1.6875		
Density test passed. The value is in concordance with the literature data for this substance, namely 1.6843 g/cm ³ [15] or 1.69039 [20]. The value communicated by 3M is 1.680 g/cm ³ [16]							
Purified PF 5060 (n-C₆F₁₄)							
Pycnometer no.	$V (cm^3)$	w_i	w_f	$w_i - w_f$	$d_o = d_c (g/cm^3)$	Density (g/cm ³)	CERN req. value
33	50.6650	38.2668	123.829	85.5622	1.6888	1.6891	1.660 - 1.700
73	51.4177	26.8448	113.710	86.8652	1.6894		
Density test passed							
FC 72 3M (n-C₆F₁₄)							
Pycnometer no.	$V (cm^3)$	w_i	w_f	$w_i - w_f$	$d_o = d_c (g/cm^3)$	Density (g/cm ³)	CERN req. value
33	50.6650	38.2670	123.766	85.499	1.6875	1.6886	1.660 - 1.700
73	51.4177	26.8448	113.727	86.8822	1.6897		
Density test passed. The value communicated by 3M is 1.7 g/cm ³ [21]							
PF 5060 DL (n-C₆F₁₄)							
Pycnometer no.	$V (cm^3)$	w_i	w_f	$w_i - w_f$	$d_o = d_c (g/cm^3)$	Density (g/cm ³)	CERN req. value
33	50.6650	38.2670	123.871	85.604	1.6896	1.6944	1.660 - 1.700
73	51.4177	26.8448	114.213	87.369	1.6992		
Density test passed. The value communicated by 3M is 1.685 g/cm ³ [22]							

¹³ Determined at 20 °C in previous experiment using demineralized water (18.2 MΩ·cm; T = 20 °C)

All 3M fluids (PF 5060, PF 5060 DL and purified PF 5060) passed the density test, the values being within the normal limits, in agreement to the literature data [23]. These values meet the CERN quality requirements. The value for PP1 fluid product is in good agreement to the literature data for pure perfluoro 2-methyl pentane (iso-C₆F₁₄) [15].

5. CONCLUSIONS AND NEXT WORK

The aim of Part I of the work was successfully accomplished using the chemistry laboratory analytical techniques and methods, which were sensitive to the parameters or the properties of interest: these techniques should be used for the future characterization and analyses.

The following perfluorocarbon fluids supplied to CERN: PF 5060 DL, PP1 and C₃F₈ were found compliant to the CERN quality requirements and to the analysis certificates delivered by the respective producers.

Other perfluorocarbon fluids were not compliant in all points, as expected, to our quality requirements, mainly concerning the hydrogen content, i.e. FC-72 and PF 5060.

The acidity (HF content) of the all received fluids was below the imposed CERN limits.

The measurements carried out also shown that the recommended procedure for the double bonds and the reducing agents control using KMnO₄ is not enough sensitive for this application and it was replaced by our own FT-IR procedure.

The preliminary purification tests on less pure fluids were very promising. The work will continue and the tests will be adapted and optimized, thus making other perfluorocarbon fluids quality grades to meet the CERN quality requirements. In such a way the potential suppliers and the range of the available fluids, possibly less expensive, may be advantageously enlarged.

The measurements to be realized on the different gamma irradiated perfluorocarbon fluids (doses of 28 kGy and 56 kGy) should show the radiation induced levels of acidity, the presence in these fluids of possible radiation induced polymers or pre-polymers as well as the eventual necessary on line purification to maintain a constant quality during their use.

Owing the chemical characterization and the measurements performed in the Chemistry Laboratory, some points of the CERN technical (quality) requirements have to be consequently adapted for the future purchases.

REFERENCES

- [1] Determination of density of Flutec dyed blue fluid; Method FC-40-108 rev. 0 (F2 Chemicals Ltd. 2006)
- [2] British Standard 4522: 1988 (Method for determination of absolute density at 20 °C of liquid chemical products for industrial use)
- [3] Colthup, N., Daly, L. H., Wiberley, S. E., "*Introduction to Infrared and Raman Spectroscopy*", III-rd. Edition, Academic Press Inc. 1990, Ch. 5, p 215
- [4] Fluka Riedel de Haen, "Produits Chimiques et Réactifs du Analytiques Laboratoire, Sigma Aldrich, 2005-2006, p. 1702
- [5] ABCR catalog reference F06072 <http://www.chemexper.com/>
- [6] Grafstein, D., "Detection, Estimation and removal of Impurities in Fluorocarbon Liquids" in: *Analytical Chemistry*, 26(3) 523 - 525 (1954)
- [7] Hariguchi, H., "*Bibliography on IR Spectra*", Sankyo Shuppan Co., 1989, Ch. 41, p. 357
- [8] "*Infrared Spectra of Halogenated Hydrocarbons*" (Ed. Clara D. Craver), III-rd edition, Coblenz Society Inc. 1984, p. 153 – 154
- [9] "*Determination of potassium permanganate test for reducing agents in fluorocarbon fluids*", Laboratory Test Method - F2 Chemicals Ltd., Method: FC-40-116
- [10] Moiseeva, N. I., Gekhman, A. E., Moiseev, I. I., *Journal of Molecular Catalysis A: Chemical*, 117, 39 - 55 (1997)
- [11] Sandford, G., *Tetrahedron*, 59, 437 - 454 (2003)
- [12] "Determination of distillation range of fluorocarbon fluids" Method FC-40-106, rev. 0 (F2-Chemicals Ltd.)
- [13] British Standard 658: 1994 - Specification for apparatus for determination of distillation range (including flask and receivers)
- [14] CERN Technical Specification IT-3397/TS
- [15] <http://www.chemexper.com/>
- [16] Certificate de compliance for the product PF 5060 3M *Performance fluid* product ID ZF-0002-0798-3 (issued by DATE S.A.38770 La Motte d'Aveillans, France)
- [17] Performance fluid PF 5060 DL Product information 2006 (<http://multimedia.mmm.com/mws/mediawebserver.dyn?6666660Zjcf61Vs6EVs666xWiCOrrrrQ->)
- [18] <http://rem.jrc.cec.eu.int/etex/15.htm>
- [19] Certificate of Analysis Batch No 0294/ Ref. No. P51917
- [20] Caco A.I. et al "Thermophysical properties of some perfluorocompounds", *Fifteenth Symposium on Thermophysical Properties*, Boulder, CO, USA, June 22 - 27, 2003
- [21] FC-72 Fluorinert Brand Electronic Liquid, Safety data sheet
- [22] Certificate of Analysis Product PF-5060 DL, Lot. Nbr. 20032/ 13 Mar. 2006
- [23] 3M Specialty Fluids Newsletter Vol1 No.1, April 1995